



Size: 1.25in x 0.70in x 0.31in (31.8mm x 17.8mm x 7.9mm)

FEATURES

- Epoxy Coating
- Compact Package
- Several Outputs Voltages Available (Contact Factory for more information)
- Through Hole Package
- Dual Output
- 1000VDC Isolation
- Low Power

DESCRIPTION

The NED series provides an isolated primary and secondary HIGH pulse (or open collector LOW) that can be used to turn on a MOSFET or Thyristor to shut down and discharge a power supply in the event of a nuclear blast. The NED series is designed to survive the nuclear environment while sensitive electronics cannot, and must be de-energized. The pulse duration of the NED series can be increased with the addition of ceramic capacitors at the V_{shld} pin. The output pins will continue to provide the output HIGH (or LOW) as long as the hold-up time even with the removal of primary and secondary input. Customization available.

NED PIN Assignments

Pin	Name	Function	Description
1	Vpri_rtn (GND)	Primary side return	
2	NED_tst	NED Test	HIGH causes a NED even to trigger. NED_tst is referenced to the Vpri_rtn.
3	NED_rst	NED Reset	HIGH resets NET detector (NEDp & NEDs) after NED event.
4	NEDpoc	Primary side referenced open-collector output	Provides open-collector output LOW after NED event. NEDpoc is referenced to the Vpri_rtn.
5	Vsec_rtn (RTN)	Secondary side return	
6	NEDsoc	Secondary side referenced open-connector output	Provides open-collector output LOW after NED event. NEDsoc is referenced to Vsec_rtn.
7	FLAG	FLAG Output	Provides high output after NED event. Stays high as long as VsFlag is high. Does not get reset if Vpri or Vsec removed. FLAG is resourced from VsFlag and referenced to Vsec_rtn.
8	Flag_rst	FLAG Reset	LOW resets FLAG output after NED event. Note that first NED_rst must be cycled or input power removed before FLAG_rst will reset FLAG. Flag_rst is referenced to Vsec_rtn.
9	NEDs	Secondary side referenced output	Provides output high after NED event. NEDs stays high as long as inputs Vpri and Vsec are maintained. NEDs is referenced to Vsec_rtn.
10	VsFlag	Input power for FLAG output	Input for FLAG output. VsFlag is referenced to Vsec_rtn
11	Vshld	Output Hold-Up Capacitor	Adding additional capacitance to this pin increases the secondary side time HIGH duration at NEDs. If additional hold up is not desired, leave pin unconnected. See Equation 1 for value. Vshld is referenced to Vsec_rtn. Note: primary holdup time must be greater than secondary holdup time.
12	Vsec	Secondary side input	
13	NEDp	Primary side referenced output	Provides output high after NED event. Once triggered, NEDp stays high as long as input Vpri is maintained. NEDp is referenced to the Vpri_rtn.
14	Vphld	Input Hold-up Capacitor	Adding additional capacitance to this pin increases the primary side time HIGH duration at NEDp. If additional hold up is not desired, leave pin unconnected. See Equation 2 for value. Vphld is referenced to the Vpri_rtn.
15	Vpri	Primary side input	

SPECIFICATIONS

All specifications are based on 25°C, Nominal Input Voltage, and Maximum Output Current unless otherwise noted.
We reserve the right to change specifications based on technological advances.

SPECIFICATION	PIN	TEST CONDITIONS	Min	Typ	Max	Unit
PRIMARY						
Operating Voltage Range	Vpri		16	28	36	Vdc
Input Supply Current	Vpri	NEDp LOW	-	0.4	1.3	mA
Input Supply Current	Vpri	NEDp HIGH; I _{NEDp} =3mA	-	6	9	mA
Input Surge Voltage	Vpri	1s max.	-	-	75	VDC
Output Resistance	NEDp	V _{pri} =0V	-	100	-	KΩ
Output Voltage Range	NEDp		4.5	5.0	6.0	Vdc
DC Output Current	NEDp		-	-	5	mA
Peak Output Current	NEDp	500uS Max.; C _{phld} =0uF	-	-	20	mA
Delay NED _{tst} to NEDp	NEDp	Photo 1; V _{pri} =28Vdc, I _{NEDp} =3mA	-	0	-	μs
NEDp Rise Time	NEDp	Photo 1; V _{pri} =28Vdc, I _{NEDp} =3mA	-	2	-	μs
NEDp Hold-Up Time	NEDp	Photo 2; V _{pri} =16Vdc, I _{NEDp} =3mA, C _{phld} =0uF	-	2.4	-	ms
Max. Voltage	NEDpoc		-	-	36	Vdc
Max. Sink Current	NEDpoc		-	-	73	mA
Max. Input Voltage	NED _{tst}		-	-	20	Vdc
	NED _{rst}		-	-	10	Vdc
Min. On Time	NED _{tst}		10	-	-	μs
	NED _{rst}					
SECONDARY						
Operating Voltage Ranges	Vsec		4	-	8	Vdc
Input Supply Current	Vsec	NEDs LOW	-	20	50	μA
Input Supply Current	Vsec	NEDs HIGH; I _{NEDs} =3mA	-	2.5	7.5	mA
Input Surge Voltage	Vsec	1s max.	-	-	16	Vdc
Output Resistance	NEDs	V _{sec} =0V	-	100	-	KΩ
Output Voltage Range	NEDs		-	V _{sec} -1	-	Vdc
Max. Output Current	NEDs		-	-	20	mA
Delay NED _{tst} to NEDs	NEDs	Photo 2; V _{sec} =5Vdc, I _{NEDs} =20mA	-	1	-	μs
NEDs Rise Time	NEDs	Photo 2; V _{sec} =5Vdc, I _{NEDs} =20mA	-	8	-	μs
NEDs Hold-Up Time	NEDs	Photo 4; V _{sec} =5Vdc, I _{NEDs} =20mA, C _{shld} =0uF	-	100	-	μs
Max. Voltage	NEDsoc		-	-	36	Vdc
Max. Sink Current	NEDsoc		-	-	73	mA
FLAG						
Operating Voltage Range	VsFlag		4	-	8	Vdc
Input Supply Current	VsFlag	FLAG LOW	-	0	-	μA
Input Supply Current	VsFlag	FLAG HIGH; V _{sFlag} =5Vdc, I _{FLAG} =0mA	-	25	-	μA
Output Voltage Range	FLAG		-	-	V _{sFlag}	Vdc
Max. Output Current	FLAG	Photo 3; V _{sFlag} =5Vdc, I _{FLAG} =1mA	-	-	50	mA
Delay NED _{tst} to FLAG	FLAG	Photo 3; V _{sFlag} =5Vdc, I _{FLAG} =1mA	-	6	-	μs
FLAG Rise Time	FLAG	Photo 3; V _{sFlag} =5Vdc, I _{FLAG} =1mA	-	0	-	μs
FLAG Hold-Up Time	FLAG	with External Source	-	-	∞	s
Max. Input Voltage	FLAG _{rst}		-	-	10	Vdc
Min. On Time	FLAG _{rst}		10	-	-	μs
ISOLATION						
Primary-Secondary	1 minute		1000			Vdc
THERMAL						
Operating Ambient			-55	-	125	°C
Storage Temperature			-55	-	150	°C

NOTES

- Other output voltages are available. Please contact factory for more information.

**Due to advances in technology, specifications subject to change without notice.*

PHOTOS

Photo 1: NEDp (Yellow) Turn On Delay and Rise Time vs NED_{tst} (Blue)

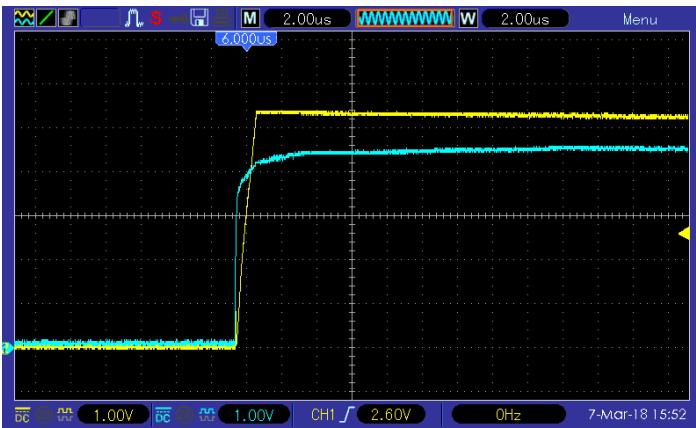

Photo 2: NEDp (Yellow) Hold Up Time while disabling Vpri (BLUE); C_{phid}=0uF

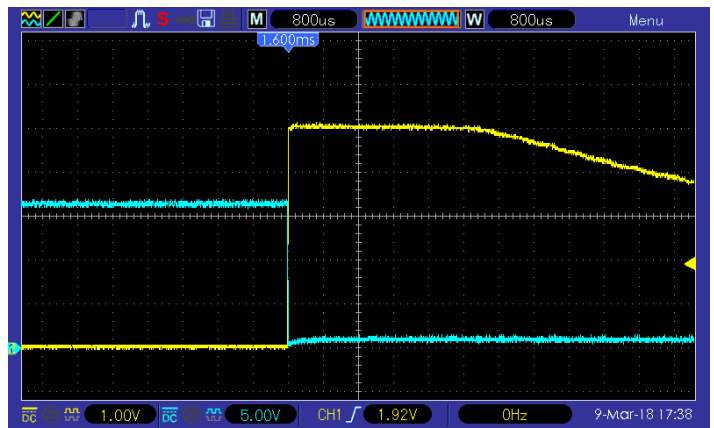

Photo 3: NEDs (Yellow) Turn On Delay and Rise Time vs NED_{tst} (Blue)

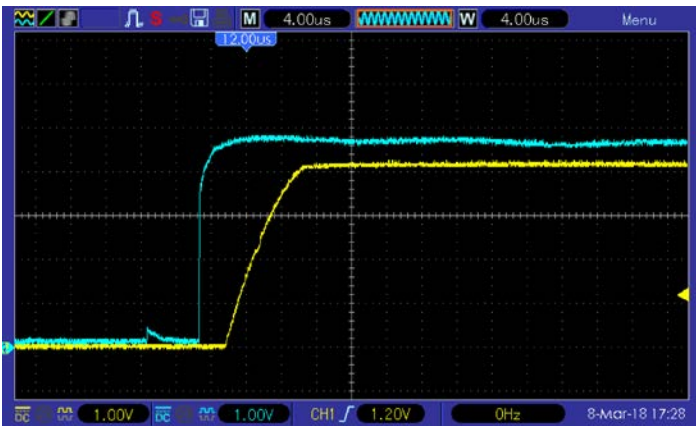

Photo 4: NEDs (Yellow) Hold Up Time while disabling Vsec (BLUE); C_{shid}=0uF

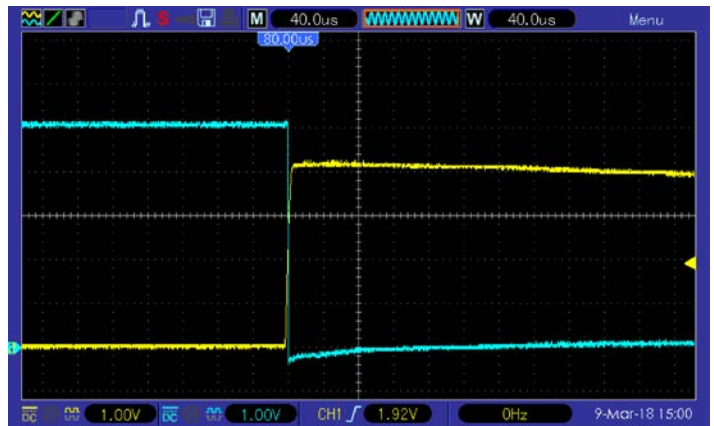
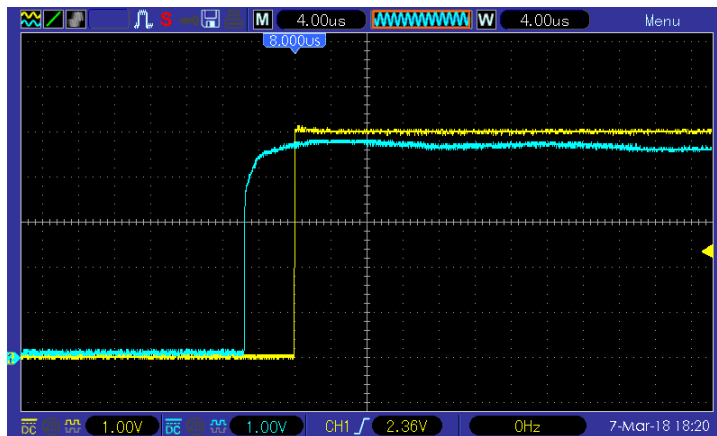
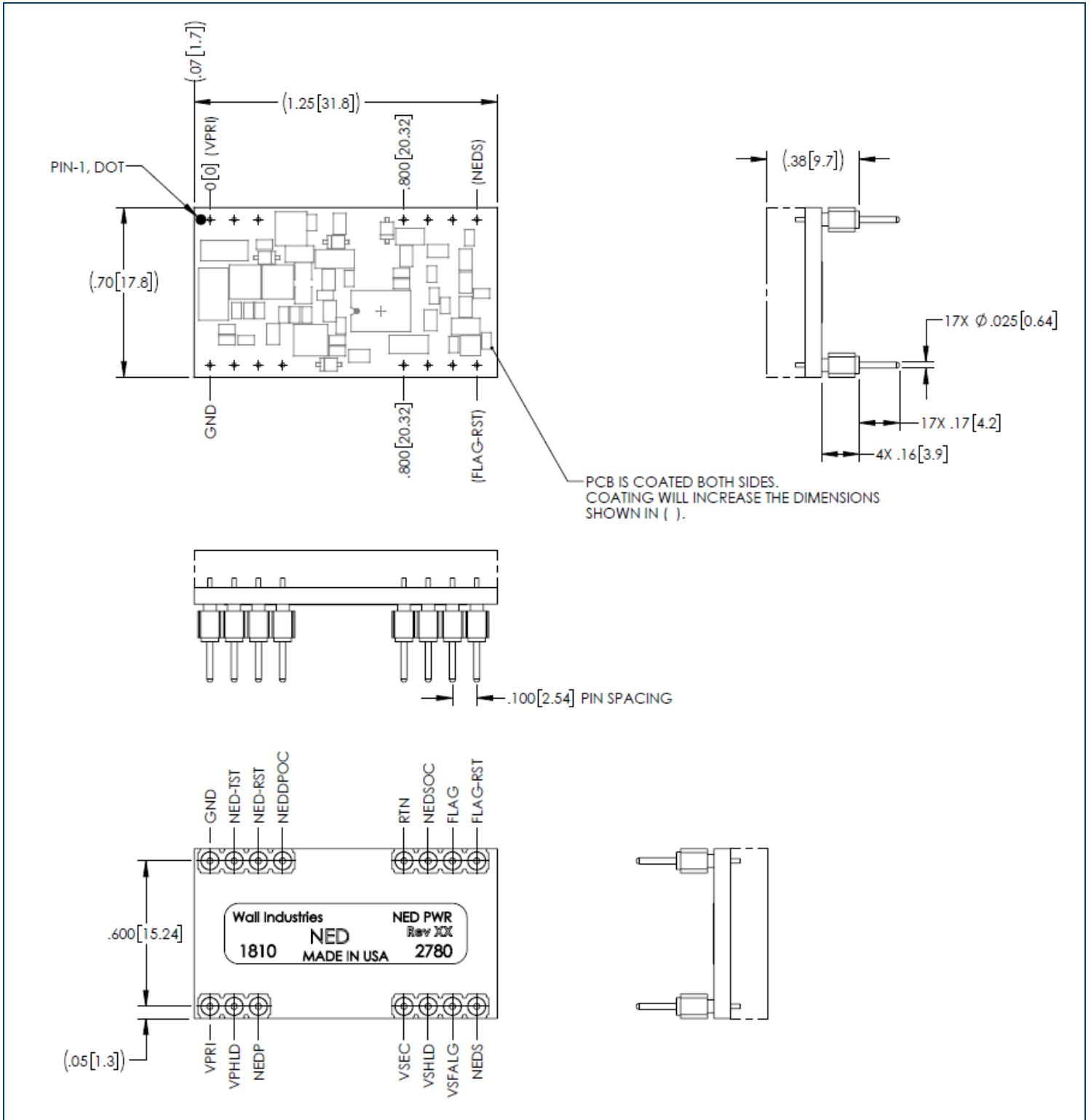

Photo 5: FLAG (Yellow) Turn On Delay and Rise Time vs. NED_{tst} (Blue)



MECHANICAL DRAWINGS



COMPANY INFORMATION

Wall Industries, Inc. has created custom and modified units for over 50 years. Our in-house research and development engineers will provide a solution that exceeds your performance requirements on-time and on budget. Our ISO9001-2008 certification is just one example of our commitment to producing a high quality, well-documented product for our customers.

Our past projects demonstrate our commitment to you, our customer. Wall Industries, Inc. has a reputation for working closely with its customers to ensure each solution meets or exceeds form, fit and function requirements. We will continue to provide ongoing support for your project above and beyond the design and production phases. Give us a call today to discuss your future projects.

Contact **Wall Industries** for further information:

Phone: ☎ (603)778-2300
Toll Free: ☎ (888)597-9255
Fax: ☎ (603)778-9797
E-mail: sales@wallindustries.com
Web: www.wallindustries.com
Address: 37 Industrial Drive
Exeter, NH 03833