

PCB Mounting ("A1" Suffix)



Size: 2.16-2.76 x 1.77-1.89 x 0.83-0.93in

Chassis Mounting 1 ("A2" Suffix)



Size: 3.78in x 2.13in x 1.16-1.25in

Chassis Mounting 2 ("A3" Suffix)



Size: 3.90in x 2.13in x 1.16-1.25in

DIN Rail Mounting ("A4" Suffix)



Size: 3.78in x 2.13in x 1.34-1.44in



OPTIONS

- Mounting
 - PCB Mount
 - Chassis Mount
 - DIN Rail
- Output Power

FEATURES

- Wide Input Voltage Range 85~305VAC (100~430VDC)
- Wide Operating Temperature Range
- PCB, Chassis Mount, or DIN Rail Mounting Available
- RoHS Compliant
- Short Circuit, Over Current, and Over Voltage Protection
- Conversion Efficiency up to 87%
- Isolation Voltage of 3000VAC
- UL/CE/CB Certifications
- IEC60950, EN60950, and UL60950 Safety Approvals

DESCRIPTION

The PSLH series of AC/DC converters offers 5-25 watts of output power in either a PCB, chassis mount, or DIN rail mounted package. This series consists of single output models with a wide input voltage range of 85~305VAC (100~430VDC). Each model in this series features a wide operating temperature range, isolation voltage of 3000VAC, as well as short circuit, over current, and over voltage protection. This series has IEC60950, EN60950, and UL60950 safety approvals and UL/CE/CB certifications. Please contact factory for order details.

MODEL SELECTION TABLE

Model Number	Input Voltage Range	Output Voltage	Output Current	Output Power	Maximum Capacitive Load	Efficiency
PSLH05-03Sx	85~305VAC (100~430VDC)	3.3V	1250mA	4W	4000µF	72%
PSLH05-05Sx		5V	1000mA	5W	4000µF	77%
PSLH05-09Sx		9V	550mA	5W	1800µF	79%
PSLH05-12Sx		12V	420mA	5W	1800µF	81%
PSLH05-15Sx		15V	330mA	5W	1500µF	82%
PSLH05-24Sx		24V	230mA	5.5W	330µF	84%
PSLH10-03Sx	85~305VAC (100~430VDC)	3.3V	2000mA	6.6W	26000µF	70%
PSLH10-05Sx		5V	2000mA	10W	9400µF	76%
PSLH10-09Sx		9V	1100mA	10W	3600µF	78%
PSLH10-12Sx		12V	900mA	10W	2400µF	80%
PSLH10-15Sx		15V	700mA	10W	1200µF	81%
PSLH10-24Sx		24V	450mA	10W	370µF	82%
PSLH15-03Sx	85~305VAC (100~430VDC)	3.3V	3000mA	9.9W	36000µF	74%
PSLH15-05Sx		5V	2800mA	14W	20000µF	78%
PSLH15-09Sx		9V	1600mA	15W	6000µF	79%
PSLH15-12Sx		12V	1250mA	15W	3000µF	82%
PSLH15-15Sx		15V	1000mA	15W	3000µF	82%
PSLH15-24Sx		24V	625mA	15W	900µF	84%
PSLH15-48Sx		48V	320mA	15W	370µF	85%
PSLH20-03Sx	85~305VAC (100~430VDC)	3.3V	3500mA	11.5W	48000µF	75%
PSLH20-05Sx		5V	3500mA	17.5W	12240µF	78%
PSLH20-09Sx		9V	2100mA	20W	5600µF	79%
PSLH20-12Sx		12V	1600mA	20W	5400µF	83%
PSLH20-15Sx		15V	1300mA	20W	2400µF	84%
PSLH20-24Sx		24V	850mA	20W	1840µF	85%
PSLH25-03Sx	85~305VAC (100~430VDC)	3.3V	4100mA	13.5W	48000µF	75%
PSLH25-05Sx		5V	4100mA	20.5W	12240µF	78%
PSLH25-09Sx		9V	2500mA	22.5W	5600µF	79%
PSLH25-12Sx		12V	2100mA	25W	5400µF	83%
PSLH25-15Sx		15V	1600mA	24W	2400µF	84%
PSLH25-24Sx		24V	1100mA	26.4W	1440µF	85%
PSLH25-48Sx		48V	500mA	24W	800µF	87%

SPECIFICATIONS

All specifications are based on 25°C, Humidity <75%, Nominal Voltage, and Rated Load unless otherwise noted.
We reserve the right to change specifications based on technological advances.

SPECIFICATION	TEST CONDITIONS	Min	Typ	Max	Unit	
INPUT SPECIFICATIONS						
Input Voltage Range	AC Input	85		305	VAC	
	DC Input	100		430	VDC	
Input Frequency		47		63	Hz	
Input Current	115VAC	PSLH05 Models		0.125	A	
		PSLH10 Models		0.26		
		PSLH15 Models		0.37		
		PSLH20/PSLH25 Models		0.6		
	230VAC	PSLH05 Models		0.08		
		PSLH10 Models		0.16		
		PSLH15 Models		0.22		
		PSLH20/PSLH25 Models		0.34		
Inrush Current	115VAC	PSLH05/PSLH10/PSLH15 Models		10	A	
		PSLH20/PSLH25 Models		15		
	230VAC	PSLH05/PSLH10 Models		15		
		PSLH15 Models		20		
		PSLH20/PSLH25 Models		30		
Leakage Current	0.3mA RMS typ./230VAC/50Hz					
Recommended External Input Fuse ⁽²⁾	PSLH05 Models		1A/300V, Slow Fusing			
	PSLH10/PSLH15 Models		2A/300V Slow Fusing			
	PSLH20/PSLH25 Models		3.15A/300V, Slow Fusing			
Hot Plug	Unavailable					
OUTPUT SPECIFICATIONS						
Output Voltage	See Table					
Voltage Accuracy			±2		%	
Line Regulation	Full Load			±0.5	%	
Load Regulation	0%-100% Load			±1	%	
Output Power	See Table					
Output Current	See Table					
Minimum Load	0				%	
Maximum Capacitive Load	See Table					
Ripple & Noise ⁽³⁾	20MHz bandwidth, peak to peak value.		50	100	mV	
Trim	PSLH20/PSLH25 Models				±10	
Hold-Up Time	115VAC Input		15		mS	
	230VAC Input		80			
Temperature Coefficient			±0.02		%/°C	
PROTECTION						
Short Circuit Protection	Hiccup, Continuous, Self-Recovery					
Over Current Protection	I _o Self-Recovery		≥110		%	
Over Voltage Protection	PSLH05 Models		Over Voltage Shutdown		VDC	
	PSLH10/PSLH15/PSLH20/PSLH25 Models		3.3/5VDC Output			≤7.5
			9VDC Output			≤12
			12/15VDC Output			≤20
			24VDC Output			≤30
			48VDC Output			≤60
ENVIRONMENTAL SPECIFICATIONS						
Operating Temperature			-40	+70	°C	
Storage Temperature	PSLH05/PSLH10/PSLH15		-40	+105	°C	
	PSLH20/PSLH25		-40	+85		
Welding Temperature	Wave-Soldering		260±5°C; Time: 5~10S			
	Manual-Welding		360±10°C; Time: 3~5S			
Storage Humidity			95		%RH	
Power Derating	-40°C to -10°C		2		%°C	
	50°C to +70°C (PSLH25 Models)		3			
	55°C to +70°C (Others)		4			
MTBF	MIL-HDBK-217F@25°C		300,000		H	

SPECIFICATIONS

All specifications are based on 25°C, Humidity <75%, Nominal Voltage, and Rated Load unless otherwise noted.
We reserve the right to change specifications based on technological advances.

SPECIFICATION	TEST CONDITIONS		Min	Typ	Max	Unit
GENERAL SPECIFICATIONS						
Typ. Efficiency	@230VAC		See Table			
Switching Frequency	PSLH05 Models			65	132	kHz
	PSLH10 Models			100		
	PSLH15/PSLH20/PSLH25 Models			65		
Isolation Voltage	Test Time: 1 min.	Input-Output	3000			VAC
		Input - 	2000			
PHYSICAL SPECIFICATIONS						
Weight	PCB Mount	PSLH05/PSLH10 Models	2.65oz (75g)			
		PSLH15 Models	3oz (85g)			
		PSLH20/PSLH25 Models	4.23oz (120g)			
	Chassis Mount Option 1 & 2	PSLH05/PSLH10 Models	4.41oz (125g)			
		PSLH15 Models	4.76oz (135g)			
		PSLH20/PSLH25 Models	6oz (170g)			
	DIN Rail Mount	PSLH05/PSLH10 Models	5.82oz (165g)			
PSLH15 Models		6.17oz (175g)				
PSLH20/PSLH25 Models		7.41oz (210g)				
Dimensions (L x W x H)	PCB Mount ("A1" Option)		2.16-2.76in x 1.77-1.89in x 0.83-0.93in (55-70mm x 45-48mm x 21-23.5mm)			
	Chassis Mount Option 1 ("A2" Option)		3.78in x 2.13in x 1.16-1.25in (96.1mm x 54mm x 29.5-32mm)			
	Chassis Mount Option 2 ("A3" Option)		3.90in x 2.13in x 1.16-1.25in (99mm x 54mm x 29.5-32mm)			
	DIN Rail Mount ("A4" Option)		3.78in x 2.13in x 1.34-1.44in (96.1mm x 54mm x 34.1-36.6mm)			
Case Material			Black Flame-Retardant & Heat Resistant Plastic (UL94-V0)			
Cooling Method			Free Convection			
SAFETY CHARACTERISTICS						
Safety Approvals & Certifications			IEC60950/EN60950/UL60950 ⁽⁹⁾			
EMI	CE	CISPR32/EN55032	Class B			
	RE	CISPR32/EN55032	Class B			
ESD	IEC/EN61000-4-2	Contact ±6kV/Air±8kV	Perf. Criteria B			
RS	IEC/EN61000-4-3	10V/m	Perf. Criteria A			
EFT	IEC/EN61000-4-4	±2kV	Perf. Criteria B			
		±4kV (See Fig. 2 for recommended circuit)	Perf. Criteria B			
Surge	IEC/EN61000-4-5	Line to Line ±1kV/Line to Ground ±2kV	Perf. Criteria B			
		Line to Line ±2kV/Line to Ground 4kV (See Fig. 2 for recommended circuit)	Perf. Criteria B			
CS	IEC/EN61000-4-6	10Vr.m.s	Perf. Criteria A			
PFM	IEC/EN61000-4-8	10A/m	Perf. Criteria A			
Voltage Dips, Short Interruptions & Voltage Variations Immunity	IEC/EN61000-4-11	0%-70%	Perf. Criteria B			
Safety Class	PSLH15 Models		Class II			
	Others		Class I			

NOTES

- "X" in model number represents mounting options. "X" can either be "A1" for PCB Mounting, "A2" for Chassis Mount option 1, "A3" for Chassis Mount option 2, or "A4" for DIN rail mount.
- Special package series include fuse.
- Ripple & Noise is tested with "parallel cable" method. Contact factory for more information.
- There is no pin  on PSLH15 models.
- If the product is not operating within required load range, product performance cannot be guaranteed to comply with all parameters in the datasheet.
- Customization available.
- Performance indexes of the product models listed are as recorded in data sheet. Indexes of non-standard model products will exceed the mentioned requirements. Please contact factory for more information.
- Products classified according to ISO14001 and related environmental laws & regulates and should be handled by qualified units.
- This product is Listed to applicable standards and requirements by UL.

**Due to advances in technology, specifications subject to change without notice.*

DERATING CURVES

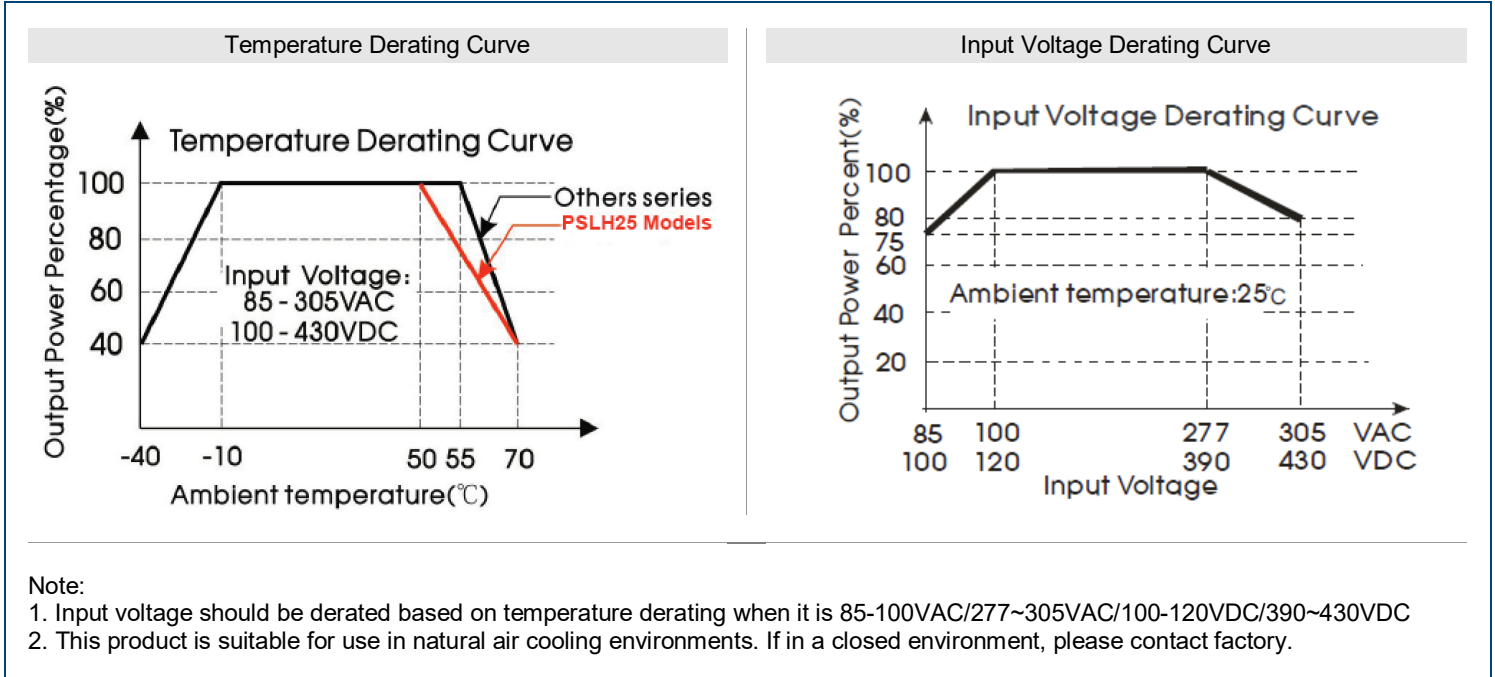

EFFICIENCY GRAPHS

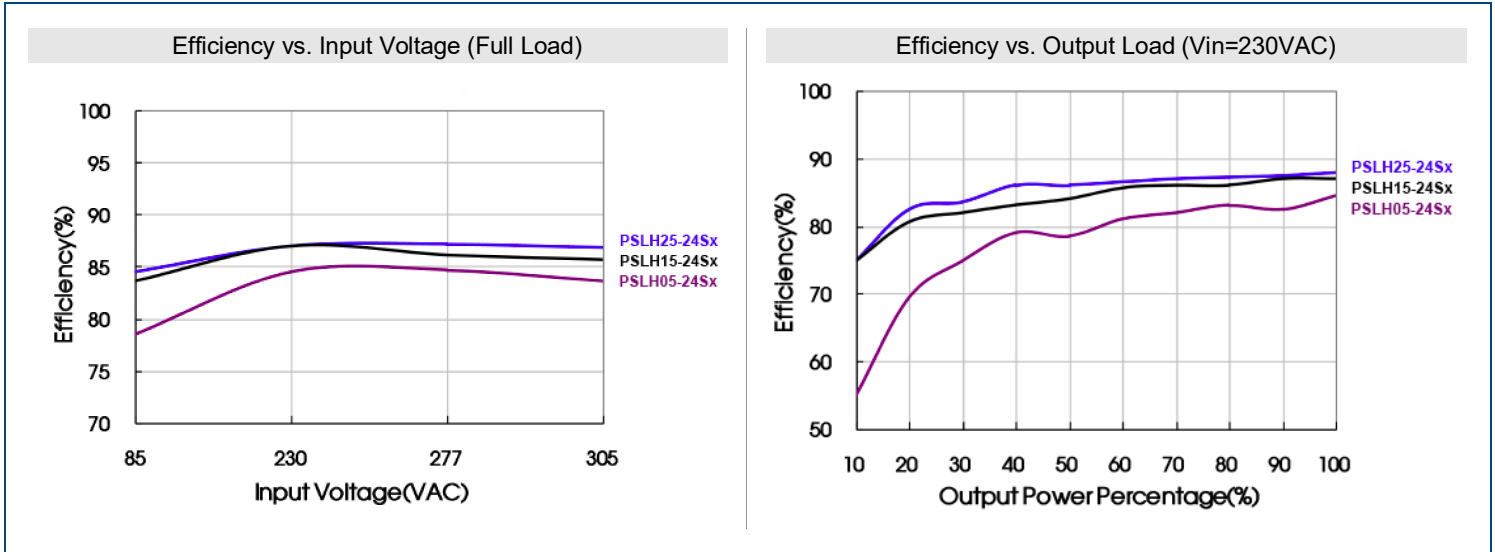

MECHANICAL DRAWINGS

PCB Mount ("A1" Suffix)

THIRD ANGLE PROJECTION 

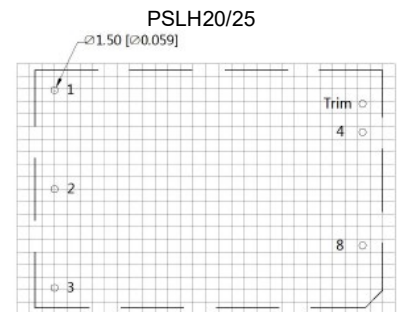
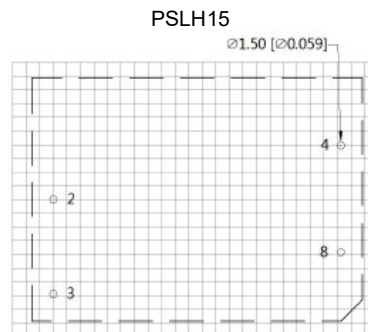
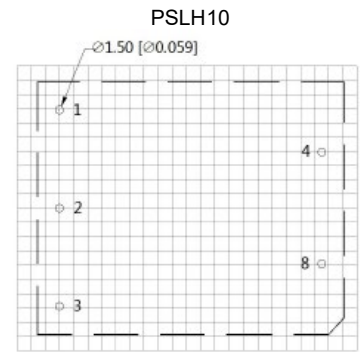
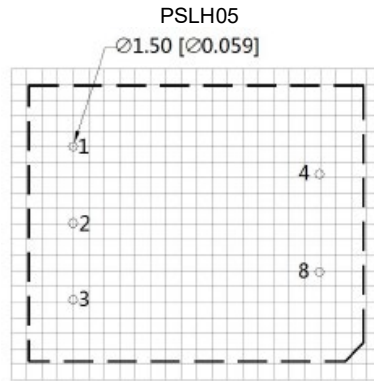
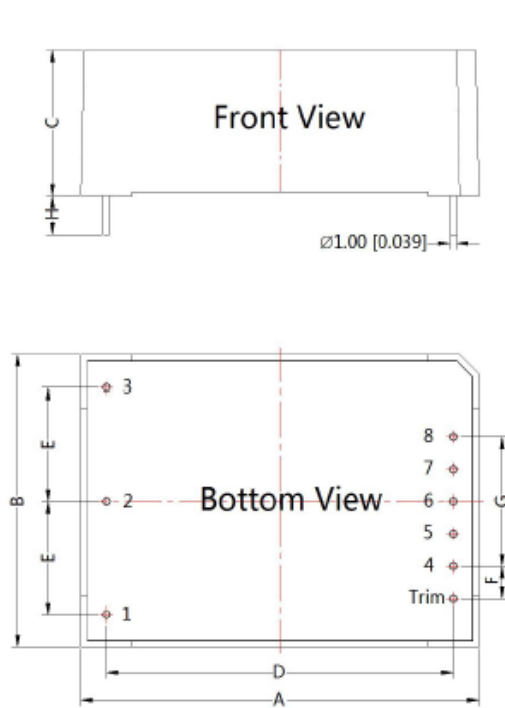

Note:
Unit: [mm]
Pin diameter tolerances: ± 0.10 [± 0.004]
Pin Length (H) ≥ 6.00 [0.236]
General Tolerances: ± 0.50 [± 0.020]

Dimensions (Unit: mm)

No.	PSLH05	PSLH10	PSLH15	PSLH20	PSLH25
A	55.00	55.00	62.00	70.00	70.00
B	45.00	45.00	45.00	48.00	48.00
C	21.00	21.00	22.50	23.50	23.50
D	40.50	47.00	54.00	62.00	62.00
E	12.50	17.50	17.50	20.00	20.00
F	-	-	-	5.75	5.75
G	16.00	20.00	20.00	23.00	23.00
6(Min)					

Models Weight

Weight (Typ.)	PSLH05	PSLH10	PSLH15	PSLH20	PSLH25
	75g	75g	85g	120g	120g

PIN Connection

Pin	PSLHxx-xxSA1
1	
2	AC(N)
3	AC(L)
4	-Vo
5	No Pin
6	No Pin
7	No Pin
8	+Vo
Trim	Trim**

There is no pin "1"  on PSLH15-xxSA1 models.
Trim**: only for PSLH20/25 models

Chassis Mount Option 1 ("A2" Suffix)

THIRD ANGLE PROJECTION 

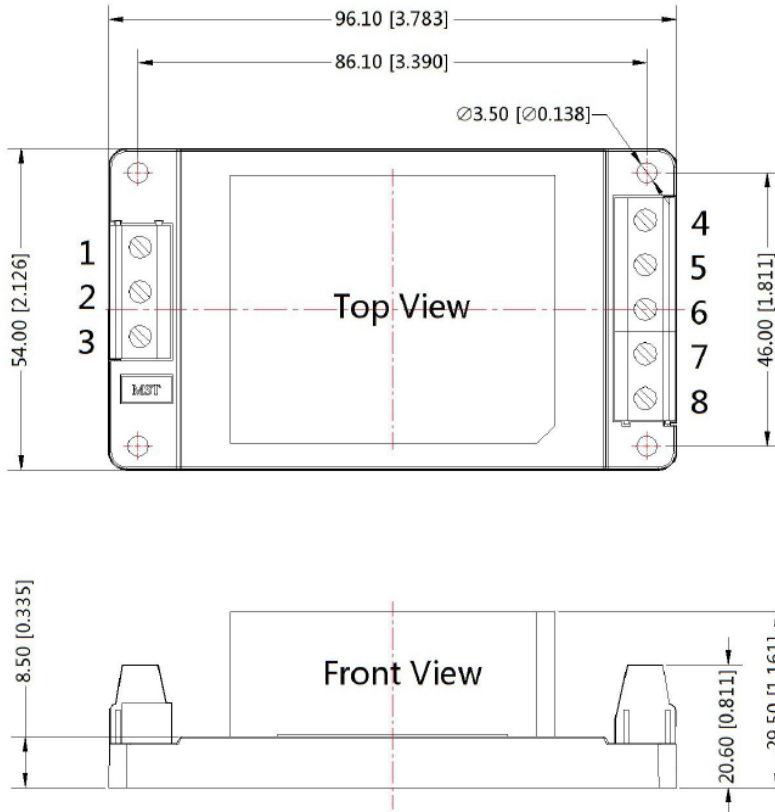

Pin-Out

Pin	PSLHxx-xxA2
1	
2	AC(N)
3	AC(L)
4	-Vo
5	NC
6	NC/Trim**
7	NC
8	+Vo

There is no pin "1" on the PSLH15-xxSA2 models. NC/Trim** The pin is Trim on the PSLH20/25-xxSA2 series and is not connected on other single output products.

Note:
Unit:mm[inch]
Wire Range: 24~12AWG
Tightening Torque: Max 0.4 N·m
General Tolerances: ±1.00 [±0.039]
* This drawing references PSLH10-xxSA2 models. The height of other models is different.

Dimensions (Unit: mm)

Model	Dimensions
PSLH05-xxSA2	96.1 x 54.0 x 29.5mm
PSLH10-xxSA2	96.1 x 54.0 x 29.5mm
PSLH15-xxSA2	96.1 x 54.0 x 31.0mm
PSLH20-xxSA2	96.1 x 54.0 x 32.0mm
PSLH25-xxSA2	96.1 x 54.0 x 32.0mm

Models Weight

Weight	PSLH05	PSLH10	PSLH15	PSLH20	PSLH25
Typ.	125g	125g	135g	170g	170g

Chassis Mount ("A3" Suffix)

THIRD ANGLE PROJECTION 

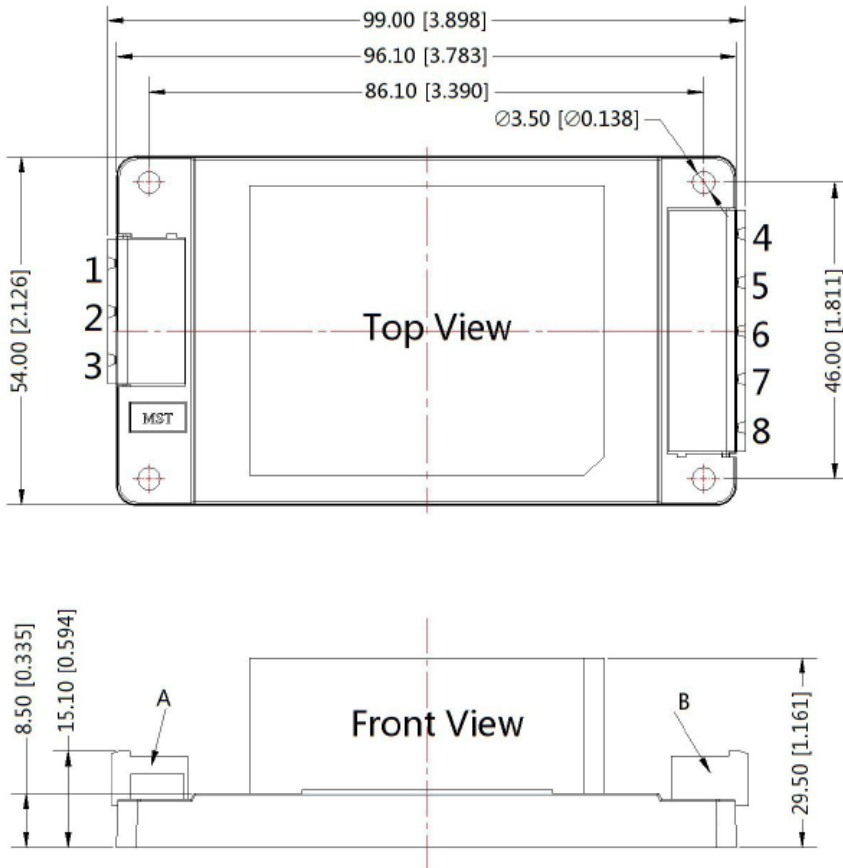

Pin Out

Pin	PSLHxx-xxSA3
1	
2	AC(N)
3	AC(L)
4	-Vo
5	NC
6	NC/Trim**
7	NC
8	+Vo

There is no pin "1" on the PSLH15-xxSA3 models.
NC/Trim**: The pin is Trim on the PSLH20/25-xxSA3 models and not connected on other single output products.

Note:

Unit: [mm]

General tolerances: ±1.00 [±0.039]

A: DEGSON P/N: 2EDGRC-7.5-03P-14-100A (H)

B: DEGSON P/N: 2EDGRC-7.5-05P-14-100A (H)

* This drawing references LH10-xxSA3 models. The height of other models is different.

Dimensions (Unit: mm)

Model	Dimensions
PSLH05-xxSA3	99.0 x 54.0 x 29.5mm
PSLH10-xxSA3	99.0 x 54.0 x 29.5mm
PSLH15-xxSA3	99.0 x 54.0 x 31.0mm
PSLH20-xxSA3	99.0 x 54.0 x 32.0mm
PSLH20-xxSA3	99.0 x 54.0 x 32.0mm

Models Weight

Weight (Typ.)	PSLH05	PSLH10	PSLH15	PSLH20	PSLH25
	125g	125g	135g	170g	170g

DIN Rail ("A4" Suffix)

THIRD ANGLE PROJECTION 

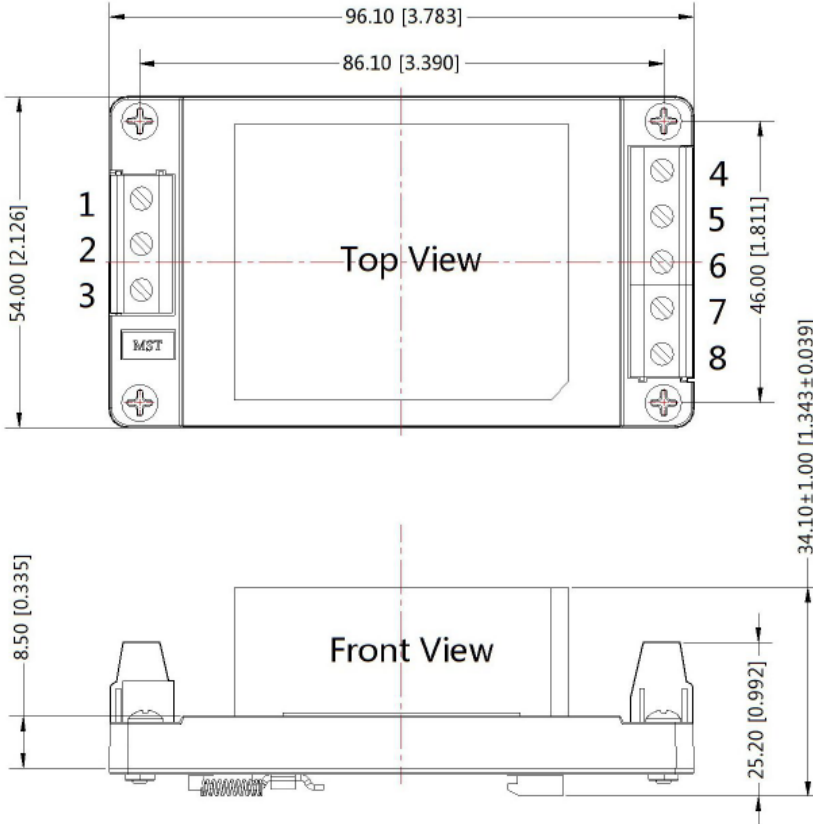

Pin-Out	
Pin	PSLHxx-xxA4
1	
2	AC(N)
3	AC(L)
4	-Vo
5	NC
6	NC/Trim**
7	NC
8	+Vo

There is no pin "1" on the PSLH15-xxSA4 models.
NC/Trim** The pin is Trim on the PSLH20/25-xxSA4 series and is not connected on other single output products.

Note:
Unit:mm[inch]
Mounting Rail: TS35, rail needs to connect safety ground
Wire Range: 24-12AWG
Tightening Torque: Max 0.4 N·m
General Tolerances: ±1.00 [±0.039]
* This drawing references PSLH10-xxSA4 models. The height of other models is different.

Dimensions (Unit: mm)

Model	Dimensions
PSLH05-xxSA4	96.1 x 54.0 x 34.1mm
PSLH10-xxSA4	96.1 x 54.0 x 34.1mm
PSLH15-xxSA4	96.1 x 54.0 x 35.6mm
PSLH20-xxSA4	96.1 x 54.0 x 36.6mm
PSLH20-xxSA4	96.1 x 54.0 x 36.6mm

Models Weight

Weight	PSLH05	PSLH10	PSLH15	PSLH20	PSLH25
Typ.	165g	165g	175g	210g	210g

DESIGN REFERENCE

Typical Application Circuit

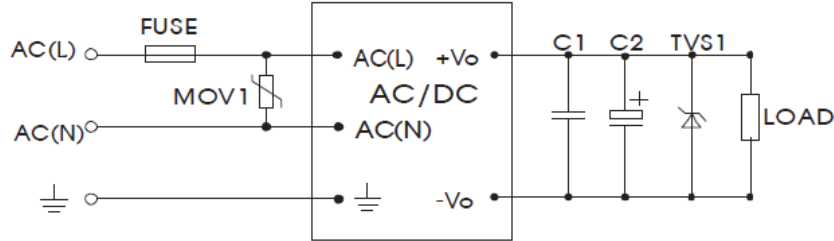

Fig. 1

Model	C1 (uF)	C2 (uF)	FUSE	MOV	TVS	Model	C1 (uF)	C2 (uF)	FUSE	MOV	TVS
PSLH05-03Sx	1	330	1A/300V slow fusing, necessary	S14K350	SMBJ7.0A	PSLH15-15Sx	1	220	2A/300V slow fusing, necessary	S14K350	SMBJ20A
PSLH05-05Sx	1	330			SMBJ7.0A	PSLH15-24Sx	1	68			SMBJ30A
PSLH05-09Sx	1	120			SMBJ12A	PSLH15-48Sx	1	33			SMBJ64A
PSLH05-12Sx	1	120			SMBJ20A	PSLH20-03Sx	1	330			SMBJ7.0A
PSLH05-15Sx	1	68			SMBJ20A	PSLH20-05Sx	1	330			SMBJ7.0A
PSLH05-24Sx	1	68			SMBJ30A	PSLH20-09Sx	1	220			SMBJ12A
PSLH10-03Sx	1	470	2A/300V, slow fusing, necessary		SMBJ7.0A	PSLH20-12Sx	1	220	SMBJ20A		
PSLH10-05Sx	1	330			SMBJ7.0A	PSLH20-15Sx	1	220	SMBJ20A		
PSLH10-09Sx	1	120			SMBJ12A	PSLH20-24Sx	1	220	SMBJ30A		
PSLH10-12Sx	1	120			SMBJ20A	PSLH25-03Sx	1	330	SMBJ7.0A		
PSLH10-15Sx	1	120			SMBJ20A	PSLH25-05Sx	1	330	SMBJ7.0A		
PSLH10-24Sx	1	68			SMBJ30A	PSLH25-09Sx	1	330	SMBJ12A		
PSLH15-03Sx	1	680	2A/300V, slow fusing, necessary	SMBJ7.0A	PSLH25-12Sx	1	330	SMBJ20A			
PSLH15-05Sx	1	680		SMBJ7.0A	PSLH25-15Sx	1	330	SMBJ20A			
PSLH15-09Sx	1	470		SMBJ12A	PSLH25-24Sx	1	120	SMBJ30A			
PSLH15-12Sx	1	220		SMBJ20A	PSLH25-48Sx	1	68	SMBJ64A			

Note: Output filtering capacitor C2 is electrolytic capacitor. It is recommended to apply electrolytic capacitor with high frequency and low resistance. For capacitance and current of capacitor, please refer to datasheet. Capacitance voltage reduced to at least 80%. C1 is ceramic capacitor, which is used to filter high-frequency noise. TVS is a recommended component to protect post-circuits if converter fails.

EMC Solution-Recommended Circuit

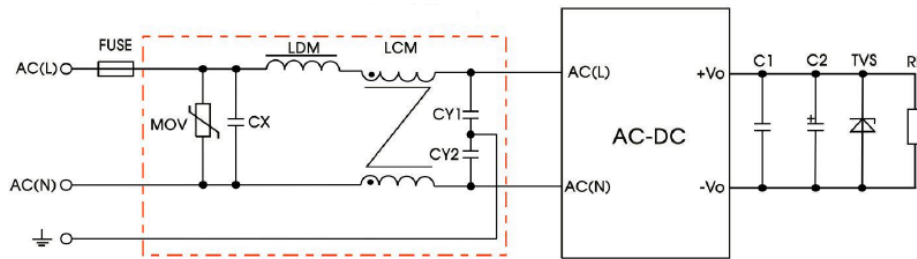
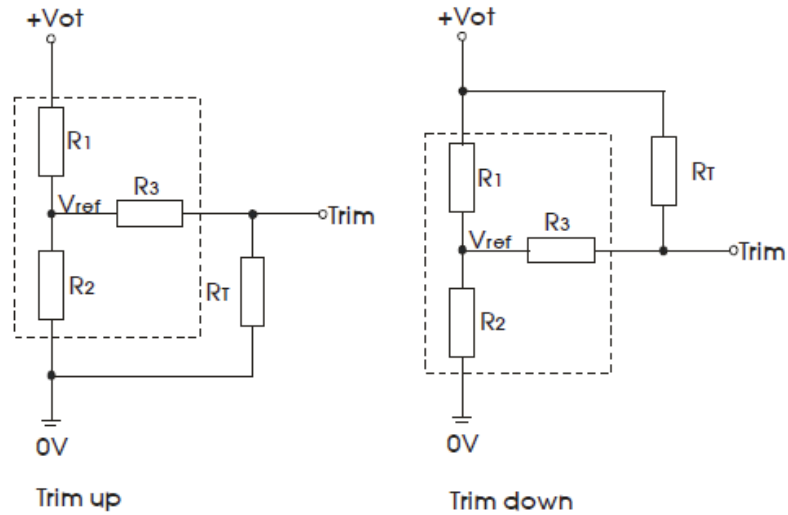

Fig 2

Element Model	Recommended Value	Element Model	Recommended Value
MOV1	S14K350	*	EMC Filter
CY1, CY2	1000pF/400VAC	FUSE	PSLH05
CX	0.1uF/310VAC		PSLH10/15
LCM	10mH *		PSLH20/25
LDM	4.7uH/2A	-	-

* Contact factory for suggestion.

Typical Application Circuit



Applied circuits of Trim (Part in broken line is the interior of models)

Calculation formula of Trim resistance:

up: $R_T = \frac{aR_2}{R_2 - a} - R_3$ $a = \frac{V_{ref}}{V_{ot} - V_{ref}} \cdot R_1$

down: $R_T = \frac{aR_1}{R_1 - a} - R_3$ $a = \frac{V_{ot} - V_{ref}}{V_{ref}} \cdot R_2$

R_T is Trim resistance
 a is a self-defined parameter with no real meaning

Vout	R1 (KΩ)	R2 (KΩ)	R3 (KΩ)	Vref (V)	Vot (V)
3.3V	3.3	1.98	1	1.24	Output voltage after regulation, variation ≤ ±10%
5V	3.3	3.3	1	2.5	
9V	7.5	2.87	1	2.5	
12V	3.83	1	1	2.5	
15V	7.5	1.5	1	2.5	
24V	8.66	1	1	2.5	
48V	68	3.73	1	2.5	

MODEL NUMBER SETUP

PSLH	10	-	05	S	X
Series Name	Output Power		Output Voltage	Output Quantity	Mounting Type
	05: 4-5W 10: 6.6-10W 15: 9.9-15W 20: 13.5-20W 25: 13.5-25W		03: 3.3V 05: 5V 09: 9V 12: 12V 15: 15V 24: 24V 48: 48V	S: Single	A1: PCB Mount A2: Chassis Mount Option 1 A3: Chassis Mount Option 2 A4: DIN Rail

COMPANY INFORMATION

Wall Industries, Inc. has created custom and modified units for over 50 years. Our in-house research and development engineers will provide a solution that exceeds your performance requirements on-time and on budget. Our ISO9001: 2015 certification is just one example of our commitment to producing a high quality, well-documented product for our customers.

Our past projects demonstrate our commitment to you, our customer. Wall Industries, Inc. has a reputation for working closely with its customers to ensure each solution meets or exceeds form, fit and function requirements. We will continue to provide ongoing support for your project above and beyond the design and production phases. Give us a call today to discuss your future projects.

Contact **Wall Industries** for further information:

Phone: ☎ (603)778-2300
Toll Free: ☎ (888)597-9255
Fax: ☎ (603)778-9797
E-mail: sales@wallindustries.com
Web: www.wallindustries.com
Address: 37 Industrial Drive
Exeter, NH 03833

©2019 Wall Industries, Inc. Specifications subject to change without notice. Wall Industries is not responsible for typographical errors. The information contained herein is for informational purposes only. This information is provided by Wall Industries and we make no representations or warranties of any kind, express or implied, about the completeness, accuracy, reliability, suitability or availability with respect to the information contained in this document for any purpose. All product and manufacturer names are trademarks or registered trademarks of their respective companies.