

Wall Industries, Inc.

JFCW20 SERIES

**4:1 Ultra Wide Input Voltage Range
Single & Dual Outputs
Industry Standard Package and Footprint
20 Watt DC/DC Power Converter**



FEATURES

- 20 Watts Maximum Output Power
- Single and Dual Outputs
- Industry Standard Pin-Out
- Small Size and Low Profile: 1.0" x 1.0" x 0.39"
- 4:1 Ultra Wide Input Voltage Range
- High Efficiency up to 91%
- 1600VDC I/O Isolation
- Ultra Low Quiescent Current
- Remote ON/OFF Control
- Fixed Switching Frequency
- Over Voltage, Over Load, and Short Circuit Protected
- Six-Sided Continuous Shield
- EMI Meets EN55022 Class A Without External Filter
- CE Mark Meets 2006/95/EC, 93/68/EEC, and 2004/108/EC
- UL60950-1, EN60950-1, and IEC60950-1 Safety Approvals
- Compliant to RoHS EU Directive 2002/95/EC

APPLICATIONS

- Wireless Networks
- Telecom / Datacom
- Industry Control Systems
- Measurement Equipment
- Semiconductor Equipment

OPTIONS

- Negative Remote ON/OFF
- Without Trim Pin
- Without ON/OFF Pin
- Heatsink

DESCRIPTION

The JFCW20 series of DC/DC power converters provides 20 watts of output power in a 1.0 x 1.0 x 0.39 inch industry standard package and footprint. This series has single and dual output models with 4:1 ultra wide input voltage ranges of 9-36VDC and 18-75VDC. Some features include high efficiency, ultra low quiescent current, 1600VDC I/O isolation, remote ON/OFF, and trimmable output voltage. This series is also protected against over voltage, over current, input under voltage, and short circuit conditions. All models are RoHS compliant and have UL60950-1, EN60950-1, and IEC60950-1 safety approvals.

SPECIFICATIONS: JFCW20 SERIES						
All specifications are based on 25°C, Nominal Input Voltage, and Maximum Output Current unless otherwise noted. We reserve the right to change specifications based on technological advances.						
SPECIFICATION	TEST CONDITIONS	Min	Nom	Max	Unit	
INPUT SPECIFICATIONS						
Input Voltage Range	24VDC nominal input models	9	24	36	VDC	
	48VDC nominal input models	18	48	75		
Input Surge Voltage (1 sec max)	24VDC nominal input models			50	VDC	
	48VDC nominal input models			100		
Start-Up Voltage	24VDC nominal input models			9	VDC	
	48VDC nominal input models			18		
Shutdown Voltage	24VDC nominal input models		8		VDC	
	48VDC nominal input models		16			
Input Reflected Ripple Current	Nominal Vin and full load		30		mAp-p	
Input Filter		Pi type				
OUTPUT SPECIFICATIONS						
Output Voltage		See Table				
Line Regulation	Low line to high line at full load	Single Output Models	-0.2		+0.2	%
		Dual Output Models	-0.5		+0.5	
Load Regulation	No load to full load	Single Output Models	-0.2		+0.2	%
		Dual Output Models	-1.0		+1.0	
	10% Load to 90% Load	Single Output Models	-0.1		+0.1	
		Dual Output Models	-0.8		+0.8	
Cross Regulation (Dual Output Models)	Asymmetrical load 25% to 100% full load	-5		+5	%	
Voltage Adjustability (See Note 6)	Single Outputs	24Vout	-10		+20	%
		Others	-10		+10	%
Voltage Accuracy		-1		+1	%	
Output Power				20	W	
Output Current		See Table				
Ripple & Noise (20MHz Bandwidth)		See Table				
Transient Response Recovery Time	25% load step change		250		µs	
Start-Up Time	Nominal Vin and constant resistive load	Power Up		30	ms	
		Remote ON/OFF		30		
Minimum Load		0			%	
Temperature Coefficient		-0.02		+0.02	%/°C	
PROTECTION						
Over Voltage Protection	3.3V output models	3.7		5.4	VDC	
	5V output models	5.6		7.0		
	12V output models	13.5		19.6		
	15V output models	16.8		20.5		
	24V output models	29.1		32.5		
Over Load Protection	% of full load at nominal input		150		%	
Short Circuit Protection		Continuous, automatic recovery				
GENERAL SPECIFICATIONS						
Efficiency	Nominal Vin and full load	See Table				
Switching Frequency	3.3Vout, 5Vout Models	248	275	303	KHz	
	Others	297	330	363		
Isolation Voltage	Input to Output	1600			VDC	
	Input (Output) to Case	1000				
Isolation Resistance	500VDC	1			GΩ	
Isolation Capacitance				1500	pF	
REMOTE ON/OFF (See Note 7)						
Positive Logic (standard)	DC/DC ON			Open or 3V ~ 15V		
	DC/DC OFF			Short or 0V ~ 1.2V		
Negative Logic (option)	DC/DC ON			Short or 0V ~ 1.2V		
	DC/DC OFF			Open or 3V ~ 15V		
Input Current of Remote Control Pin	Nominal Vin	-0.5		+1.0	mA	
Remote Off State Input Current	Nominal Vin		2.0		mA	
ENVIRONMENTAL SPECIFICATIONS						
Operating Ambient Temperature	Without derating	-40		+60	°C	
	With derating	+60		+101		
Maximum Case Temperature				+105	°C	
Storage Temperature		-55		+125	°C	
Thermal Impedance (See Note 8)	Natural convection		17.6		°C/Watt	
	Natural convection with heatsink		14.8			
Relative Humidity (non-condensing)		5		95	% RH	
Thermal Shock		MIL-STD-810F				
Vibration		MIL-STD-810F				
MTBF (See Note 1)	MIL-HDBK-217F, Full Load	1,469,000 hours				
PHYSICAL SPECIFICATIONS						
Weight		0.53oz (15g)				
Case Material		Nickel-coated copper				
Base Material		FR4 PCB				
Potting Material		Silicon (UL94-V0)				
Dimensions (L x W x H)		1.0 x 1.0 x 0.39 inches (25.4 x 25.4 x 9.9 mm)				
SAFETY & EMC CHARACTERISTICS						
Safety Approvals		IEC60950-1, UL60950-1, EN60950-1				
EMI (See Note 9)	EN55022	Class A, Class B				
ESD	EN61000-4-2	Air ±8KV and Contact ±6KV				
Radiated Immunity	EN61000-4-3	10 V/m				
Fast Transient (See Note 10)	EN61000-4-4	±2KV				
Surge (See Note 10)	EN61000-4-5	±2KV				
Conducted Immunity	EN61000-4-6	10 Vrms				
Power Frequency Magnetic Field	EN61000-4-8	100A/m continuous, 100A/m 1 second				

MODEL SELECTION TABLES

SINGLE OUTPUT MODELS										
Model Number	Input Voltage Range	Output Voltage	Output Current		Input Current		Output ⁽⁴⁾ Ripple & Noise	Output Power	Efficiency ⁽⁴⁾	Maximum ⁽⁵⁾ Capacitive Load
			Min. Load	Full Load	No Load ⁽³⁾	Full Load ⁽²⁾				
JFCW24S3.3-20	24 VDC (9 – 36 VDC)	3.3 VDC	0mA	4500mA	10mA	754mA	75mVp-p	14.85W	88%	7000µF
JFCW24S5-20		5 VDC	0mA	4000mA	10mA	980mA	75mVp-p	20W	89%	5000µF
JFCW24S12-20		12 VDC	0mA	1670mA	6mA	980mA	100mVp-p	20W	89%	850µF
JFCW24S15-20		15 VDC	0mA	1330mA	6mA	980mA	100mVp-p	20W	89%	700µF
JFCW24S24-20		24VDC	0mA	833mA	10mA	-	75mVp-p	20W	91%	220µF
JFCW48S3.3-20	48 VDC (18 – 75 VDC)	3.3 VDC	0mA	4500mA	10mA	373mA	75mVp-p	14.85W	87%	7000µF
JFCW48S5-20		5 VDC	0mA	4000mA	10mA	490mA	75mVp-p	20W	89%	5000µF
JFCW48S12-20		12 VDC	0mA	1670mA	4mA	490mA	100mVp-p	20W	89%	850µF
JFCW48S15-20		15 VDC	0mA	1330mA	4mA	484mA	100mVp-p	20W	90%	700µF
JFCW48S24-20		24VDC	0mA	833mA	8mA	-	75mVp-p	20W	91%	220µF

DUAL OUTPUT MODELS										
Model Number	Input Voltage Range	Output Voltage	Output Current		Input Current		Output ⁽⁴⁾ Ripple & Noise	Output Power	Efficiency ⁽⁴⁾	Maximum ⁽⁵⁾ Capacitive Load
			Min. Load	Full Load	No Load ⁽³⁾	Full Load ⁽²⁾				
JFCW24D12-20	24 VDC (9 – 36 VDC)	±12 VDC	0mA	±833mA	6mA	980mA	100mVp-p	20W	89%	±500µF
JFCW24D15-20		±15 VDC	0mA	±667mA	6mA	969mA	100mVp-p	20W	90%	±350µF
JFCW24D24-20		±24 VDC	0mA	±417mA	12mA	-	100mVp-p	20W	91%	±100µF
JFCW48D12-20	48 VDC (18 – 75 VDC)	±12 VDC	0mA	±833mA	4mA	490mA	100mVp-p	20W	89%	±500µF
JFCW48D15-20		±15 VDC	0mA	±667mA	4mA	484mA	100mVp-p	20W	90%	±350µF
JFCW48D24-20		±24 VDC	0mA	±417mA	10mA	-	100mVp-p	20W	91%	±100µF

NOTES

- BELLCORE TR-NWT-000332. Case 1: 50% Stress, Temperature at 40°C. MIL-HDBK-217F Notice2 @Ta=25°C, Full load (Ground, Benign, controlled environment).
- Maximum value at nominal input voltage and full load.
- Typical value at nominal input voltage and no load.
- Single Outputs: 3.3-15V measured with 1µF M/C X7R and a 10µF T/C, 24V measured with 2 pcs of 6.8µF/50V X7R MLCC
Dual Outputs: 12, 15V measured with 1µF M/C X7R and a 10µF T/C for each output, 24V measured with a 4.7µF/50V X7R MLCC for each output
- Test by minimum Vin and constant resistive load.
- Trimming allows the user to increase or decrease the output voltage set point of the module. This is accomplished by connecting an external resistor between the TRIM pin and either the +Vout pin or the -Vout pin.
- The ON/OFF control pin is referenced to -Vin. To order Negative Logic Remote ON/OFF add the suffix "R" to the model number.
- Heatsink is optional and P/N: 7G-0047C-F. See "Product Standard Table" on page 5 for ordering information.
- EN55022
1) To meet Class A the module needs no external components
2) To meet Class B please refer to the filter suggestion on page 4.
- An external input filter capacitor is required if the module has to meet EN61000-4-4, EN61000-4-5. The filter capacitor suggested is Nippon chemi-con KY series, 220µF /100V, ESR 48mΩ.
- There are several different options available for this series. Please see the "Product Standard Table" on page 5 for all options and ordering information.

CAUTION: This power module is not internally fused. An input line fuse must always be used.

Due to advances in technology, specifications subject to change without notice.

DERATING CURVES

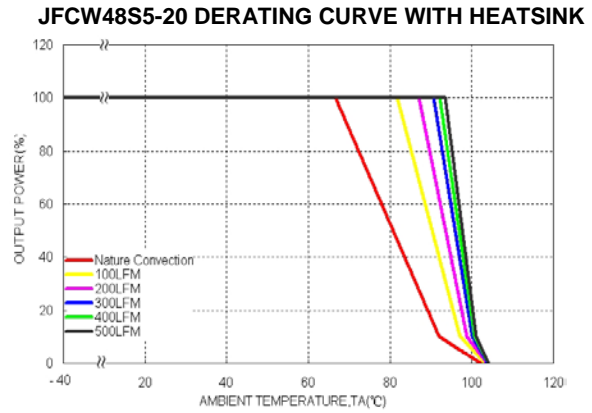
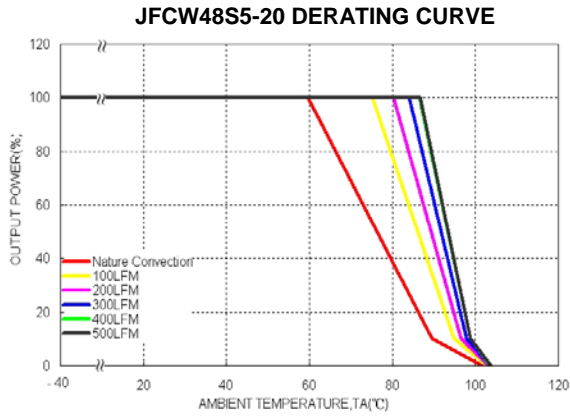

CHARACTERISTICS

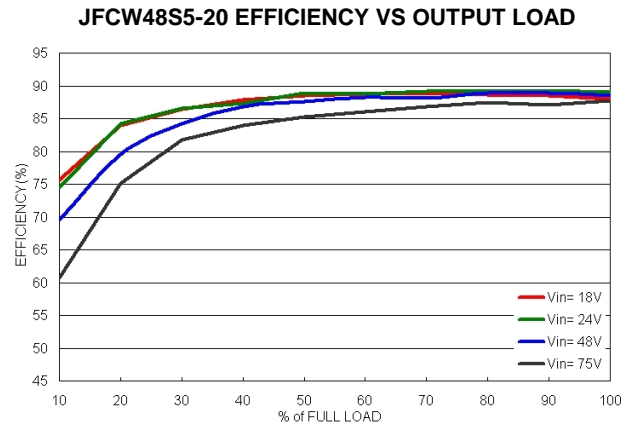
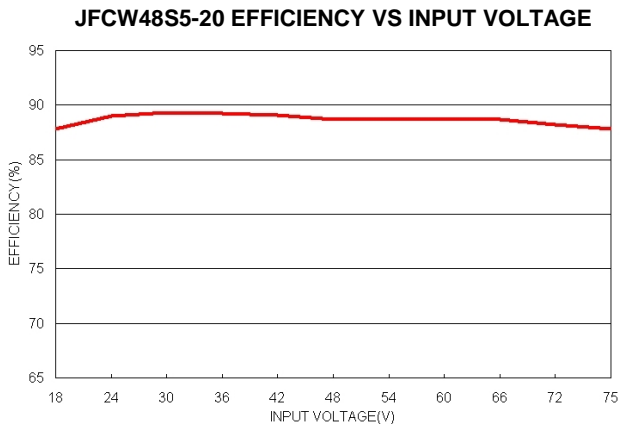

Recommended Filter for EN55022 Class B Compliance

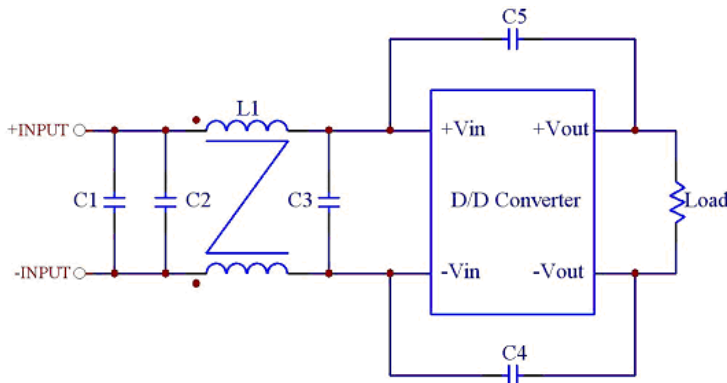

Recommended EN55022 Class B Filter Circuit Layout

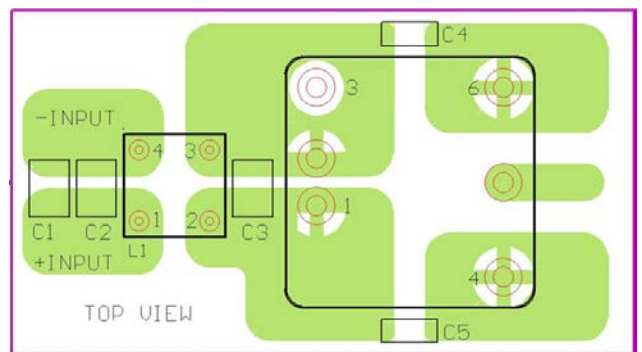

The components used in the figure above are as follows:

	C1, C2	C2	C3	C4 & C5	L1
JFCW-24xxx-20	4.7µF/50V 1812 MLCC	N/A	N/A	470pF/2KV 1808 MLCC	325µH Common Choke PMT-050
JFCW-48xxx-20	2.2µF/100V 1812 MLCC	2.2µF/100V 1812 MLCC	2.2µF/100V 1812 MLCC	1000pF/2KV 1808 MLCC	325µH Common Choke PMT-050

MECHANICAL DRAWINGS

Unit: inches (mm)

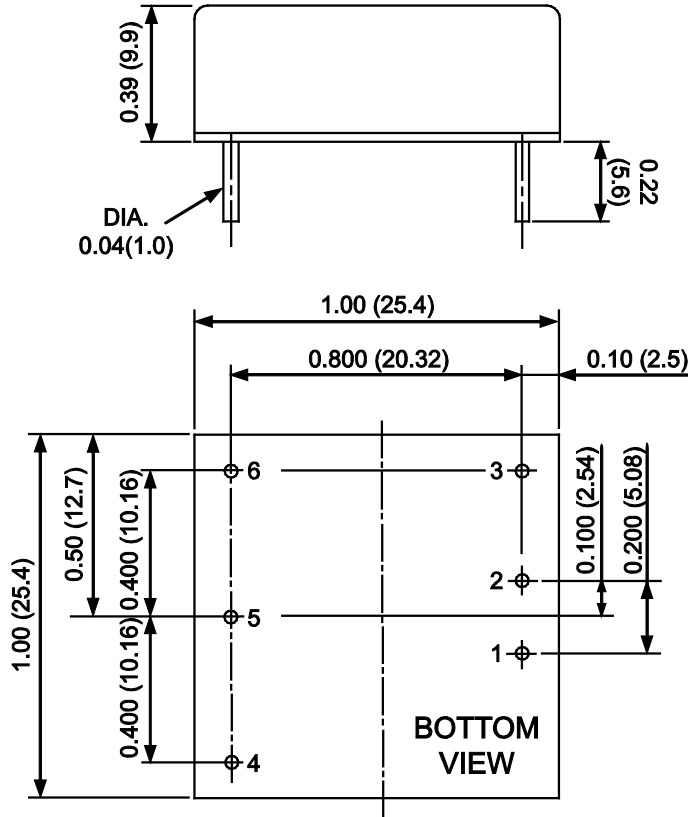

1. Tolerance: X.XX±0.02 (X.X±0.5)
 X.XXX±0.01 (X.XX±0.25)
2. Pin Pitch Tolerance: ±0.01 (±0.25)
3. Pin Dimension Tolerance: ±0.004 (±0.1)

PIN CONNECTIONS		
Pin	Single	Dual
1	+Input	+Input
2	-Input	-Input
3	ON/OFF	ON/OFF
4	+Vout	+Vout
5	Trim	Common
6	-Vout	-Vout

EXTERNAL OUTPUT TRIMMING

Output can be externally trimmed by using the method shown below.

TRIM UP

TRIM DOWN

PRODUCT STANDARD TABLE	
Option	Suffix
Positive Remote ON/OFF (standard)	No Suffix
Negative Remote ON/OFF	R
Without ON/OFF Pin	D
Without ON/OFF & Trim Pin	G
Positive Remote ON/OFF without Trim Pin	F
Negative Remote ON/OFF without Trim Pin	RF

COMPANY INFORMATION

Wall Industries, Inc. has created custom and modified units for over 50 years. Our in-house research and development engineers will provide a solution that exceeds your performance requirements on-time and on budget. Our ISO9001-2008 certification is just one example of our commitment to producing a high quality, well-documented product for our customers.

Our past projects demonstrate our commitment to you, our customer. Wall Industries, Inc. has a reputation for working closely with its customers to ensure each solution meets or exceeds form, fit and function requirements. We will continue to provide ongoing support for your project above and beyond the design and production phases. Give us a call today to discuss your future projects.

Contact **Wall Industries** for further information:

Phone: ☎ (603)778-2300
 Toll Free: ☎ (888)587-9255
 Fax: ☎ (603)778-9797
 E-mail: sales@wallindustries.com
 Web: www.wallindustries.com
 Address: 37 Industrial Drive.
 Exeter, NH 03833