

Single Output Models



Size: 0.50 x 0.37 x 0.35 inches (12.7 x 9.3 x 8.9 mm)

Dual Output Models



Size: 0.60 x 0.37 x 0.35 inches (15.3 x 9.3 x 8.9 mm)

FEATURES

- Up to 2 Watts Output Power
- Single & Dual Outputs
- 1000VDC I/O Isolation
- High Accuracy of Pin Planarity
- MTBF > 2,000,000 Hours
- -40°C to +85°C Operating Temperature
- SMT Package with Industry Standard Pin-out
- Qualified for Lead-free Reflow Solder Processes According to IPC/JEDEC J-STD-020D
- Tape & Reel Packaging Available

DESCRIPTION

The DCMSAU2 series of DC/DC converters provides 2 Watts of output power in a miniature SMT package. These converters operate over input voltage ranges of 4.5~5.5VDC, 10.8~13.2VDC, and 21.6~26.4VDC. This series also has single and dual output voltages of 5V, 12V, ±5V, ±12V, and ±15VDC. The DCMSAU2 series' impressive efficiencies enable these modules to deliver their fully rated output power from -40°C to +80°C without a heatsink or forced-air cooling. The very small footprint of these converters makes them an ideal solution for many applications where a voltage has to be isolated such as for noise reduction, ground loop elimination in digital interfaces, or where a converted voltage is required. These converters are also fully qualified for the higher temperature profile used in lead-free reflow solder processes. These converters can also be supplied in tape&reel packaging for use in automated SMD production lines.

MODEL SELECTION TABLE

SINGLE OUTPUT MODELS

Model Number	Input Voltage	Output Voltage	Output Current		Input Current		Load Regulation	Output Power	Efficiency	Maximum Capacitive Load
			Min	Max	No Load	Max Load				
DCMSAU505-2	5 VDC (4.5 – 5.5 VDC)	5 VDC	8mA	400mA	60mA	519mA	11%	2W	77%	47µF
DCMSAU512-2		12 VDC	3mA	165mA		488mA	11%	2W	81%	10µF
DCMSAU1205-2	12 VDC (10.8 – 13.2 VDC)	5 VDC	8mA	400mA	30mA	213mA	8%	2W	78%	47µF
DCMSAU1212-2		12 VDC	3mA	165mA		201mA	6%	2W	82%	10µF
DCMSAU2405-2	24 VDC (21.6 – 26.4 VDC)	5 VDC	8mA	400mA	15mA	106mA	8%	2W	78%	47µF
DCMSAU2412-2		12 VDC	3mA	165mA		101mA	5%	2W	81%	10µF

DUAL OUTPUT MODELS

Model Number	Input Voltage	Output Voltage	Output Current		Input Current		Load Regulation	Output Power	Efficiency	Maximum Capacitive Load
			Min	Max	No Load	Max Load				
DCMSAU505D-2	5 VDC (4.5 – 5.5 VDC)	±5 VDC	±4mA	±200mA	60mA	519mA	12%	2W	77%	±10µF
DCMSAU512D-2		±12 VDC	±1.5mA	±83mA		504mA	7%	2W	79%	±4.7µF
DCMSAU515D-2		±15 VDC	±1mA	±66mA		501mA	7%	2W	79%	±4.7µF
DCMSAU1212D-2	12 VDC (10.8 – 13.2 VDC)	±12 VDC	±1.5mA	±83mA	30mA	202mA	5%	2W	82%	±4.7µF
DCMSAU1215D-2		±15 VDC	±1mA	±66mA		201mA	5%	2W	82%	±4.7µF
DCMSAU2412D-2	24 VDC (21.6 – 26.4 VDC)	±12 VDC	±1.5mA	±83mA	15mA	102mA	5%	2W	81%	±4.7µF
DCMSAU2415D-2		±15 VDC	±1mA	±66mA		100mA	5%	2W	82%	±4.7µF

NOTES

1. The DCMSAU2 series requires a minimum output loading to maintain specified regulations. Operation under no-load conditions will not damage these devices; however they may not meet all listed specifications.
 2. All DC/DC converters should be externally fused at the front end for protection.
 3. Other input and output voltages may be available, please contact factory.
- *Due to advances in technology, specifications are subject to change without notice.*

SPECIFICATIONS: DCMSAU2 SERIES

All specifications are based on 25°C, Nominal Input Voltage, and Maximum Output Current unless otherwise noted.
We reserve the right to change specifications based on technological advances.

SPECIFICATION	TEST CONDITIONS	Min	Typ	Max	Unit
INPUT SPECIFICATIONS					
Input Voltage Range	5VDC nominal input models	4.5	5	5.5	VDC
	12VDC nominal input models	10.8	12	13.2	
	24 VDC nominal input models	21.6	24	26.4	
Input Surge Voltage (1sec, max.)	5VDC nominal input models	-0.7		9	VDC
	12VDC nominal input models	-0.7		18	
	24 VDC nominal input models	-0.7		30	
Reverse Polarity Input Current				0.3	A
Input Current		See Table			
Internal Power Dissipation				650	mW
Input Filter		Internal capacitor			
Input Fuse	5VDC nominal input models	1000mA slow-blow type			
	12VDC nominal input models	500mA slow-blow type			
	24 VDC nominal input models	200mA slow-blow type			
OUTPUT SPECIFICATIONS					
Output Voltage		See Table			
Output Voltage Accuracy			±1.5	±4.0	%
Output Voltage Balance (Dual Outputs)	Balanced loads		±0.1	±1.0	%
Line Regulation	For Vin change of 1%		±1.2	±1.5	%
Load Regulation	20% load to 100% load	See Table			
Output Power				2	W
Output Current		See Table			
Minimum Load	See Note 1	See Table			
Maximum Capacitive Load		See Table			
Ripple & Noise (20MHz)	Over line, over load, and over temperature		100	120	mVp-p
				200	mVp-p
				15	mV rms
Temperature Coefficient			±0.01	±0.02	%/°C
PROTECTION					
Short Circuit Protection				0.5	s
GENERAL SPECIFICATIONS					
Efficiency	Nominal input voltage and full load	See Table			
Switching Frequency		50	100	120	KHz
Isolation Voltage (I/P to O/P)	60 seconds	1000			VDC
Isolation Resistance (I/P to O/P)	500VDC	1000			MΩ
Isolation Capacitance (I/P to O/P)	100KHz, 1V		60	100	pF
ENVIRONMENTAL SPECIFICATIONS					
Operating Ambient Temperature	See derating curve	-40		+85	°C
Case Temperature				+90	°C
Storage Temperature		-50		+125	°C
Relative Humidity	Non-condensing			95	% RH
Cooling		Free air convection			
Lead Temperature	1.5mm from case for 10 sec.			300	°C
Moisture Sensitivity Level (MSL)	IPC/JEDEC J-STD-020D	Level 3			
MTBF	MIL-HDBK-217F at 25°C, ground benign	2,000,000 hours			
PHYSICAL SPECIFICATIONS					
Weight	Single Output Models	0.05oz (1.5g)			
	Dual Output Models	0.08oz (2.2g)			
Dimensions (L x W x H)	Single Output Models	0.50 x 0.37 x 0.34 inch (12.7 x 9.3 x 8.65 mm)			
	Dual Output Models	0.60 x 0.37 x 0.34 inch (15.3 x 9.3 x 8.65 mm)			
Case Material	Flammability to UL 94V-0 rated	Molding			

DERATING CURVE

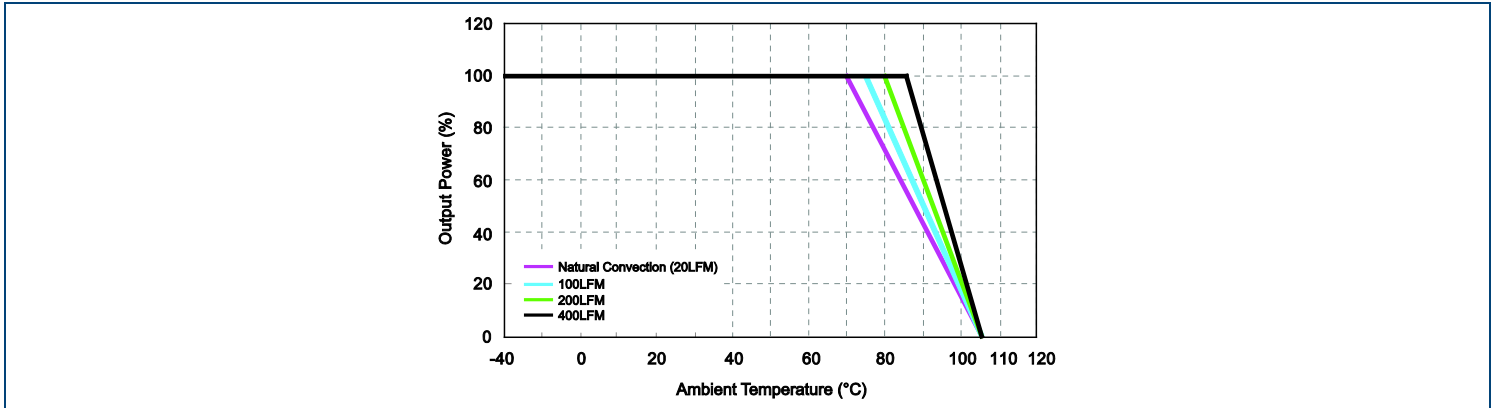

MECHANICAL DRAWINGS

Single Output Models

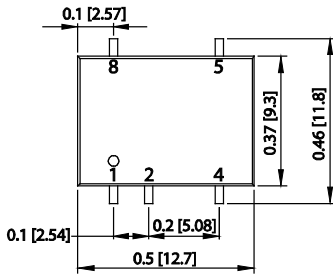

PIN CONNECTIONS	
PIN	SINGLE
1	-Vin
2	+Vin
4	-Vout
5	+Vout
7	No Pin
8	NA
10	No Pin

- Notes:
- Unit: inches [mm]
 - Tolerance: X.XX±0.01 [X.X±0.25]
X.XXX±0.005 [X.XX±0.13]
 - Pin Tolerance: ±0.002 [±0.05]
 - Weight: 0.05oz (1.5g)
 - All dimensions are for reference only

N/A: Not available for electrical connection

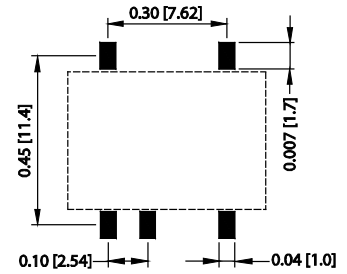

CONNECTING PIN PATTERNS

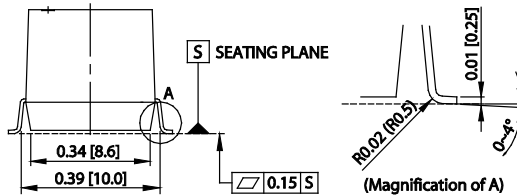
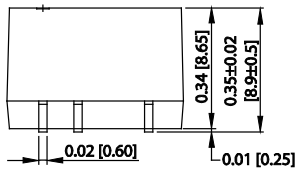

Dual Output Models

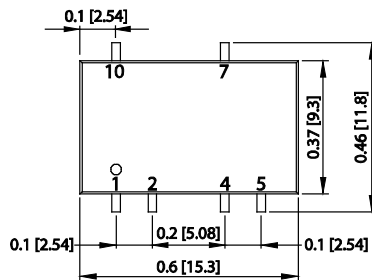

PIN CONNECTIONS	
PIN	DUAL
1	-Vin
2	+Vin
4	Common
5	-Vout
7	+Vout
8	No Pin
10	NA

- Notes:
- Unit: inches [mm]
 - Tolerance: X.XX±0.01 [X.X±0.25]
X.XXX±0.005 [X.XX±0.13]
 - Pin Tolerance: ±0.002 [±0.05]
 - Weight: 0.08oz (2.2g)
 - All dimensions are for reference only

N/A: Not available for electrical connection

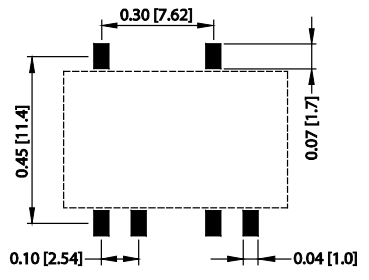

CONNECTING PIN PATTERNS

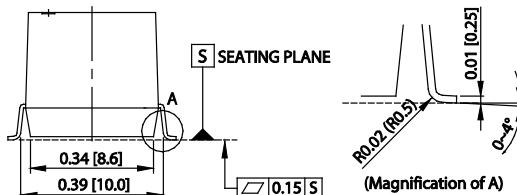
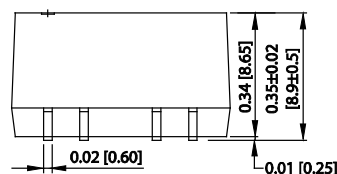

DESIGN CONSIDERATIONS

Input Reflected-Ripple Current Test Setup

Input reflected-ripple current is measured with an inductor L_{in} ($4.7\mu H$) and C_{in} ($220\mu F$, $ESR < 1.0\Omega$ at 100 KHz) to simulate source impedance. Capacitor C_{in} offsets possible battery impedance. Current ripple is measured at the input terminals of the module. Measurement bandwidth is 0-500 KHz.

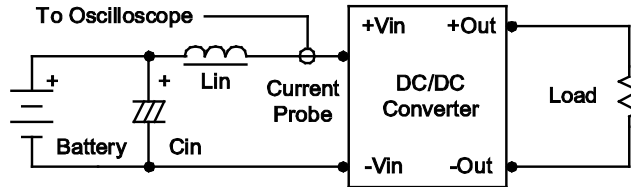

Peak-to-Peak Output Noise Measurement Test

Use a $0.33\mu F$ ceramic capacitor. Scope measurement should be made by using a BNC socket, measurement bandwidth is 0-20MHz. Position the load between 50mm and 75mm from the DC/DC converter.

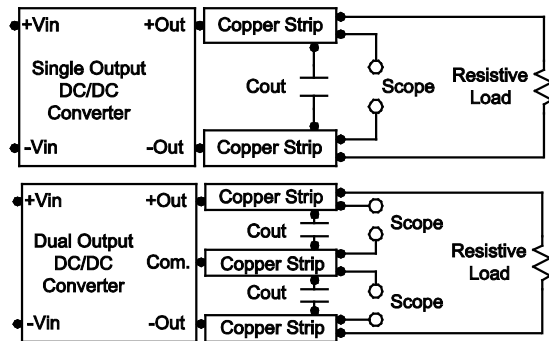

TEST SETUP

Maximum Capacitive Load

The DCMSAU2 series has a limitation of maximum connected capacitance on the output. The power module may be operated in current limiting mode during start-up, affecting the ramp-up and the start-up time. The maximum capacitance can be found in the Model Selection Table.

Input Source Impedance

The power module should be connected to a low ac-impedance input source. Highly inductive source impedances can affect the stability of the power module. In applications where power is supplied over long lines and output loading is high, it may be necessary to use a capacitor at the input to ensure startup. Capacitor mounted close to the power module helps ensure stability of the unit, it is recommended to use a good quality low Equivalent Series Resistance ($ESR < 1.0\Omega$ at 100 KHz) capacitor of $2.2\mu F$ for 5VDC input models, $1.0\mu F$ for 12VDC input models, and $0.47\mu F$ for 24VDC input models.

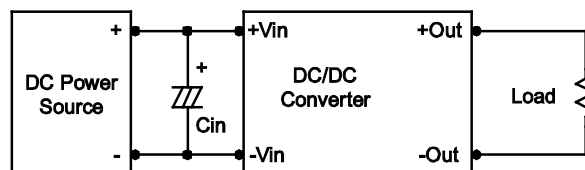

Output Ripple Reduction

A good quality low ESR capacitor placed as close as possible across the load will give the best ripple and noise performance. To reduce output ripple, it is recommended to use 1.5µF capacitors at the output.

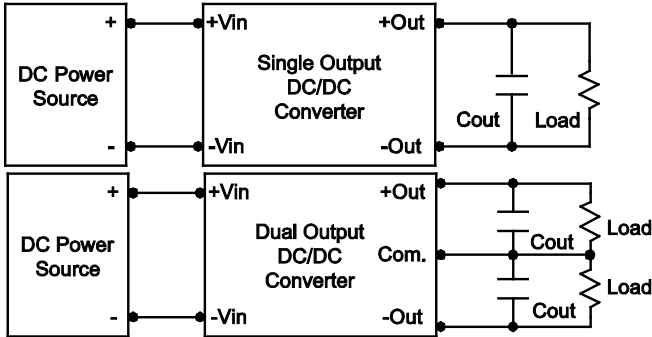

TEST SETUP

Thermal Considerations

Many conditions affect the thermal performance of the power module, such as orientation, airflow over the module, and board spacing. To avoid exceeding the maximum temperature rating of the components inside the power module, the case temperature must be kept below 90°C. The derating curves are determined from measurements obtained in a test setup.

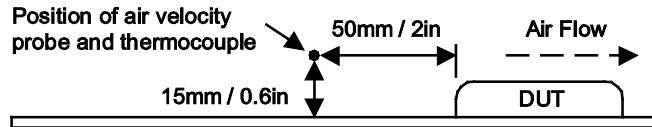

COMPANY INFORMATION

Wall Industries, Inc. has created custom and modified units for over 50 years. Our in-house research and development engineers will provide a solution that exceeds your performance requirements on-time and on budget. Our ISO9001-2008 certification is just one example of our commitment to producing a high quality, well-documented product for our customers.

Our past projects demonstrate our commitment to you, our customer. Wall Industries, Inc. has a reputation for working closely with its customers to ensure each solution meets or exceeds form, fit and function requirements. We will continue to provide ongoing support for your project above and beyond the design and production phases. Give us a call today to discuss your future projects.

Contact **Wall Industries** for further information:

- Phone: ☎ (603)778-2300
- Toll Free: ☎ (888)597-9255
- Fax: ☎ (603)778-9797
- E-mail: sales@wallindustries.com
- Web: www.wallindustries.com
- Address: 37 Industrial Drive
Exeter, NH 03833