

Standard Models

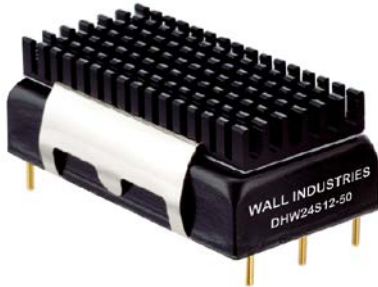

Size: 2.00 x 1.00 x 0.43 inches (50.8 x 25.4 x 11.0 mm)

Heatsink Models (Suffix "HS")



Size: 2.00 x 1.22 x 0.71 inches (50.8 x 31.0 x 18.0 mm)

FEATURES

- RoHS & UL 94V-0 Compliant
- Smallest Encapsulated 50W Converter
- 4:1 Wide Input Voltage Ranges
- Single Outputs
- Remote ON/OFF Control
- 1500VDC I/O Isolation
- High Efficiency up to 92%
- Under Voltage Lockout (UVLO)
- No Minimum Load Requirements
- Trimmable Output Voltage
- Shielded Metal Case with Isolated Base-plate
- Over Load, Short Circuit, Over Voltage, & Over Temperature Protection
- -40°C to +80°C Operating Temperature Range
- CSA/UL/IEC/EN 60950-1 Safety Approvals
- Heatsink (Optional)

DESCRIPTION

The DHW50 series is the latest generation of high performance DC/DC converters setting a new standard concerning power density. These converters offer 50 Watts of continuous output power in a 2.0" x 1.0" x 0.43" encapsulated, shielded metal package. All models have a 2:1 wide input voltage range and a precisely regulated single output. Advanced circuit topology provides a very high efficiency up to 92% and an operating temperature range of -40°C to +80°C. Further features include remote on/off, trimmable output voltage, under voltage lockout as well as over load, over voltage, short circuit, and over temperature protection. These converters are RoHS compliant and are ideal for use in battery operated equipment, instrumentation, distributed power architectures in communication and industrial electronics and many other space critical applications.

MODEL SELECTION TABLE

Model Number	Input Voltage	Output Voltage	Output Current		Input Current		Reflected Ripple Current	Over Voltage Protection	Output Power	Efficiency	Maximum Capacitive Load
			Min	Max	No Load	Max Load					
DHW24S3.3-33	24 VDC (9 - 36 VDC)	3.3 VDC	0mA	10A	80mA	1528mA	40mA	3.9 VDC	33W	90%	26,000µF
DHW24S5-50		5 VDC	0mA	10A	60mA	2290mA		6.2 VDC	50W	91%	17,000µF
DHW24S12-50		12 VDC	0mA	4.17A	80mA	2267mA		15 VDC	50W	92%	3,000µF
DHW24S15-50		15 VDC	0mA	3.33A	80mA	2263mA		18 VDC	50W	92%	2,000µF
DHW24S24-50		24 VDC	0mA	2.08A	80mA	2286mA		30 VDC	50W	91%	750µF
DHW48S3.3-33	48 VDC (18 - 75 VDC)	3.3 VDC	0mA	10A	40mA	764mA	30mA	3.9 VDC	33W	90%	26,000µF
DHW48S5-50		5 VDC	0mA	10A	30mA	1145mA		6.2 VDC	50W	91%	17,000µF
DHW48S12-50		12 VDC	0mA	4.17A	60mA	1134mA		15 VDC	50W	92%	3,000µF
DHW48S15-50		15 VDC	0mA	3.33A	60mA	1134mA		18 VDC	50W	92%	2,000µF
DHW48S24-50		24 VDC	0mA	2.08A	50mA	1143mA		30 VDC	50W	91%	750µF

SPECIFICATIONS: DHW50 SERIES

All specifications are based on 25°C, Nominal Input Voltage, and Maximum Output Current unless otherwise noted.
We reserve the right to change specifications based on technological advances.

SPECIFICATION	TEST CONDITIONS		Min	Typ	Max	Unit
INPUT SPECIFICATIONS						
Input Voltage Range	24VDC nominal input models		9	24	36	VDC
	48VDC nominal input models		18	48	75	
Input Surge Voltage (100ms max.)	24VDC nominal input models		-0.7		50	VDC
	48VDC nominal input models		-0.7		100	
Start-up Threshold Voltage	24VDC nominal input models				9	VDC
	48VDC nominal input models				18	
Under Voltage Lockout (UVLO)	24VDC nominal input models			7.5		VDC
	48VDC nominal input models			16		
Start-up Time	Nominal Vin and constant resistive load	Power Up			30	ms
		Remote On/Off			30	
Input Current			See Table			
Reflected Ripple Current (Page 9)			See Table			
Conducted EMI	for EN55032 Class A and FCC level A compliance see page 1		Internal LC Filter			
Short Circuit Current	Automatic Recovery		Hiccup mode 0.3Hz typ.			
OUTPUT SPECIFICATIONS						
Output Voltage			See Table			
Output Voltage Setting Accuracy	At 50% load and nominal Vin				±1.0	%Vnom
Line Regulation	Low line to high line at full load				±0.5	%
Load Regulation	Minimum load to full load				±0.5	%
Minimum Load			No minimum load required			
Output Voltage Trim (Note 4) (Page 5)	% of nominal output voltage	24VDC output models	-10		+20	%
		Others	-10		+10	
Output Power			See Table			
Output Current			See Table			
Ripple & Noise (20MHz BW) (Page 9)	Measured with a 1µF MLCC and a 10µF tantalum capacitor in parallel	3.3V & 5V output models		100		mVp-p
		12V, 15V, & 24V output models		150		
Transient Recovery Time (Note 1)	25% load step change			250		µs
Transient Recovery Deviation (Note 1)	25% load step change			±3	±5	%
Temperature Coefficient					±0.02	%/°C
PROTECTION						
Input Polarity Protection			none			
Over Voltage Protection (page 9)			See Table			
Over Current Protection	Hiccup		Current limitation at 150% typ. of Io max			
Thermal Protection	Shutdown temperature			110		°C
Short Circuit Protection	Automatic recovery		Hiccup Mode 0.3Hz typ.			
REMOTE ON/OFF (Page 9)						
Positive Logic	Converter On		3.5V~12V or open circuit			
	Converter Off		0V~1.2V or short circuit			
Control Input Current	On	Vctrl = 5.0V		0.5		mA
	Off	Vctrl = 0V		-0.5		
Control Common			Referenced to negative input			
Stand-by Input Current	Nominal Vin			2.5		mA
GENERAL						
Efficiency	(see efficiency curves on pages 7-8)		See Table			
Switching Frequency				285		KHz
Isolation Voltage	60 seconds		1500			VDC
	1 Second		1800			
Isolation Resistance	500VDC		1000			MΩ
Isolation Capacitance	100kHz, 1V				2200	pF
Maximum Capacitive Load			See Table			

SPECIFICATIONS: DHW50 SERIES

All specifications are based on 25°C, Nominal Input Voltage, and Maximum Output Current unless otherwise noted.
We reserve the right to change specifications based on technological advances.

SPECIFICATION	TEST CONDITIONS	Min	Typ	Max	Unit	
ENVIRONMENTAL SPECIFICATIONS						
Operating Temperature (W/O Heatsink) <i>(see derating curves on page 6)</i>	Natural air convection (20LFM)	DHW24S3.3-33, DHW48S3.3-33	-40		+61	°C
	Nominal Vin and full load	DHW24S12-50, DHW24S15-50, DHW48S12-50, DHW48S15-50	-40		+53	
		DHW24S5-50, DHW24S24-50, DHW48S5-50, DHW48S24-50	-40		+46	
Operating Temperature (W/ Heatsink) <i>(see derating curves on page 6)</i>	Natural air convection (20LFM)	DHW24S3.3-33, DHW48S3.3-33	-40		+69	°C
	Nominal Vin and full load	DHW24S12-50, DHW24S15-50, DHW48S12-50, DHW48S15-50	-40		+62	
		DHW24S12-40, DHW24S15-40	-40		+57	
Thermal Impedance (W/O Heatsink)	Natural convection (20LFM)		12.1			°C/W
	100LFM convection		9.2			
	200LFM convection		7.8			
	400LFM convection		5.2			
Thermal Impedance (W/ Heatsink)	Natural convection (20LFM)		9.8			°C/W
	100LFM convection		5.4			
	200LFM convection		4.5			
	400LFM convection		3.0			
Case Temperature				+105	°C	
Storage Temperature		-50		+125	°C	
Humidity (non-condensing)				95	% RH	
RFI		Six-sided shielded metal case				
Cooling	Natural convection is about 20LFM and is not still air (0LFM)	natural convection				
Lead Temperature	1.5mm from case for 10 seconds			260	°C	
MTBF (calculated)	MIL-HDBK-217F at 25°C, Ground Benign	230,900			hours	
PHYSICAL SPECIFICATIONS						
Weight		1.2oz (34g)				
Dimensions (L x W x H)		2.00 x 1.00 x 0.43 inches (50.8 x 25.4 x 11.0 mm)				
Case Material		Aluminum alloy, black anodized coating				
Base Material		FR4 PCB (flammability to UL 94V-0 rated)				
Potting Material		Epoxy (UL94-V0)				
Pin Material		Copper alloy with gold plate over nickel sub-plate				
Heatsink (optional)	"HS" suffix	See page 4				
SAFETY & EMC						
Safety Approvals		UL/cUL 60950-1 recognition (CSA certificate)				
		IEC/EN 60950-1 (CB-scheme)				
EMI	Conduction, EN55032, FCC part 15	Class A				
ESD	EN61000-4-2	Air: ±8KV, Contact±6KV		A		
Radiated Immunity	EN61000-4-3	10V/m		A		
Fast Transient <i>(See Note 5)</i>	EN61000-4-4	±2KV		A		
Surge <i>(See Note 5)</i>	EN61000-4-5	±1KV		A		
Conducted Immunity	EN61000-4-6	10V/m		A		

NOTES

1. Transient recovery time is measured to within 1% error band for a step change in output load from 75% to 100%.
2. We recommend protecting the converter by a slow blow fuse in the input supply line.
3. To order the converter with a heatsink, please add the suffix "HS" to the model number. (Ex: DHW24S12-50HS)
4. Do not exceed maximum power specification when adjusting the output voltage.
5. The DHW50 series can meet EN61000-4-4 & EN61000-4-5 by adding a capacitor across the input pins. Capacitor: 220uF/100V
6. Other input and output voltages may be available; please call factory for ordering details.

MECHANICAL DRAWINGS

Standard Models

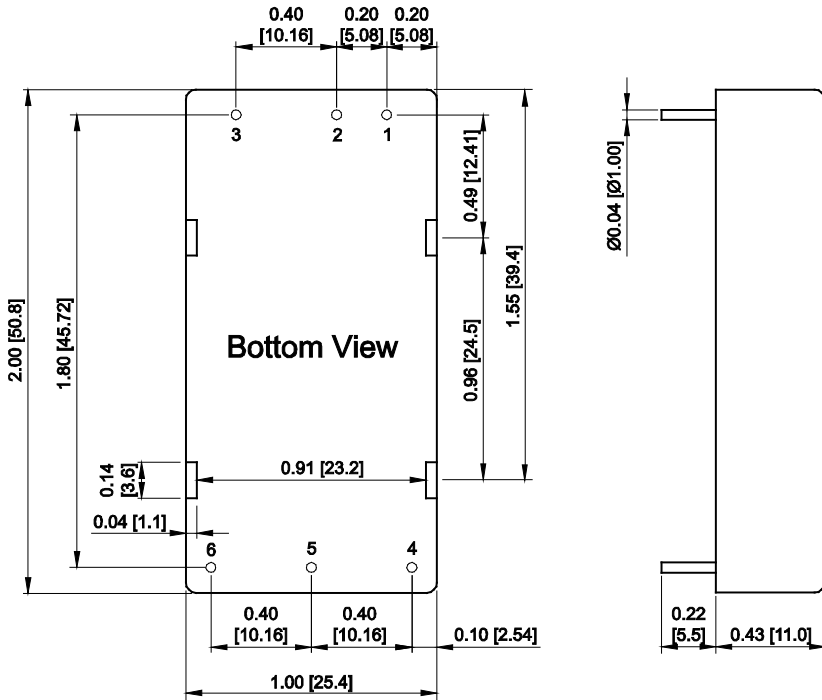

PIN CONNECTIONS	
Pin	Function
1	+Vin
2	-Vin
3	Remote On/Off
4	+Vout
5	-Vout
6	Trim

Unit: inches [mm]
 Tolerance: X.XX±0.01 [X.XX±0.25]
 X.XXX±0.005 [X.XX±0.13]
 Pin Diameter: Ø0.04±0.002 [Ø1.0±0.05]

Physical Characteristics

Case Size: 2.00 x 1.00 x 0.43 inches [50.8 x 25.4 x 11.0 mm]
 Case Material: Aluminum alloy, black anodized coating
 Base Material: FR4 PCB (flammability to UL 94V-0 rated)
 Pin Material: Copper alloy with gold plate over nickel subplate
 Potting Material: Epoxy (UL94-V0)
 Weight: 1.2oz (34g)

Heatsink Models ("HS" Suffix)

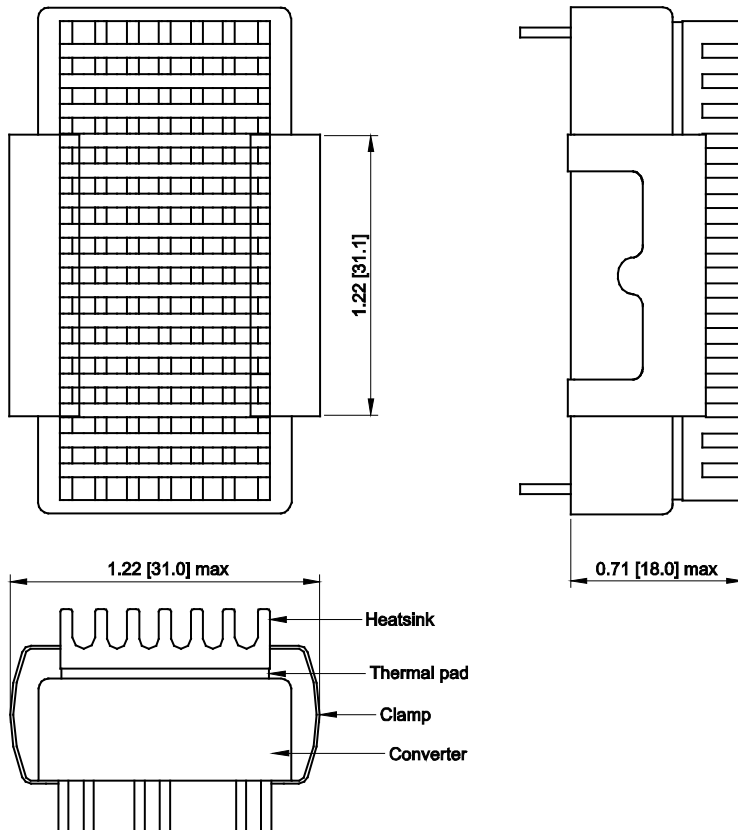

Unit: inches [mm]

Physical Characteristics

Heatsink Material: Aluminum
 Finish: Black Anodized Coating
 Heatsink Weight: 0.3oz (9g)

Advantages of Adding a Heatsink

1. To help heat dissipation and increase the stability and reliability of DC/DC converters at high operating temperature atmosphere.
2. To upgrade the operating temperature of DC/DC converters, please refer to Derating Curve.

OUTPUT VOLTAGE ADJUSTMENT

Output voltage trim allows the user to increase or decrease the output voltage of a module. This is accomplished by connecting an external resistor between the Trim pin and either the +Vout or -Vout pins. With an external resistor between the Trim and -Vout pins, the output voltage increases. With an external resistor between the Trim and +Vout pins, the output voltage set-point decreases.

Trim Up

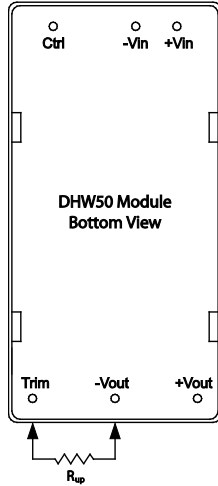

Trim Down

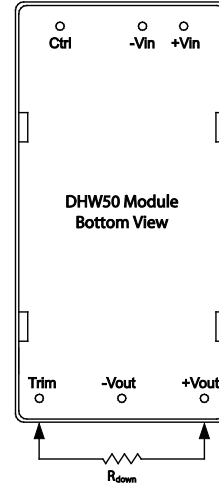

DHWXXS3.3-33		
Trim	V _{out,up}	R _{up}
1%	3.333V	70.50kΩ
2%	3.366V	29.28kΩ
3%	3.399V	16.87kΩ
4%	3.432V	10.90kΩ
5%	3.465V	7.38kΩ
6%	3.498V	5.06kΩ
7%	3.531V	3.42kΩ
8%	3.564V	2.20kΩ
9%	3.597V	1.25kΩ
10%	3.630V	0.49kΩ

DHWXXS5-50		
Trim	V _{out,up}	R _{up}
1%	5.050V	36.57kΩ
2%	5.100V	16.58kΩ
3%	5.150V	9.92kΩ
4%	5.200V	6.59kΩ
5%	5.250V	4.59kΩ
6%	5.300V	3.25kΩ
7%	5.350V	2.30kΩ
8%	5.400V	1.59kΩ
9%	5.450V	1.03kΩ
10%	5.500V	0.59kΩ

DHWXXS3.3-33		
Trim	V _{out,down}	R _{down}
1%	3.267V	63.59kΩ
2%	3.234V	30.28kΩ
3%	3.201V	18.19kΩ
4%	3.168V	11.95kΩ
5%	3.135V	8.13kΩ
6%	3.102V	5.56kΩ
7%	3.069V	3.70kΩ
8%	3.036V	2.31kΩ
9%	3.003V	1.21kΩ
10%	2.970V	0.34kΩ

DHWXXS5-50		
Trim	V _{out,down}	R _{down}
1%	4.950V	45.53kΩ
2%	4.900V	20.61kΩ
3%	4.850V	12.31kΩ
4%	4.800V	8.15kΩ
5%	4.750V	5.66kΩ
6%	4.700V	4.00kΩ
7%	4.650V	2.81kΩ
8%	4.600V	1.92kΩ
9%	4.550V	1.23kΩ
10%	4.500V	0.68kΩ

DHWXXS12-50		
Trim	V _{out,up}	R _{up}
1%	12.120V	368.92kΩ
2%	12.240V	161.92kΩ
3%	12.360V	94.97kΩ
4%	12.480V	61.86kΩ
5%	12.600V	42.12kΩ
6%	12.720V	29.00kΩ
7%	12.840V	19.66kΩ
8%	12.960V	12.66kΩ
9%	13.080V	7.23kΩ
10%	13.200V	2.89kΩ

DHWXXS15-50		
Trim	V _{out,up}	R _{up}
1%	15.150V	392.98kΩ
2%	15.300V	182.12kΩ
3%	15.450V	108.73kΩ
4%	15.600V	71.43kΩ
5%	15.750V	48.85kΩ
6%	15.900V	33.71kΩ
7%	16.050V	22.86kΩ
8%	16.200V	14.69kΩ
9%	16.350V	8.33kΩ
10%	16.500V	3.23kΩ

DHWXXS12-50		
Trim	V _{out,down}	R _{down}
1%	11.880V	394.50kΩ
2%	11.760V	179.74kΩ
3%	11.640V	106.08kΩ
4%	11.520V	68.86kΩ
5%	11.400V	46.39kΩ
6%	11.280V	31.36kΩ
7%	11.160V	20.60kΩ
8%	11.040V	12.51kΩ
9%	10.920V	6.21kΩ
10%	10.800V	1.17kΩ

DHWXXS15-50		
Trim	V _{out,down}	R _{down}
1%	14.850V	572.67kΩ
2%	14.700V	248.63kΩ
3%	14.550V	145.60kΩ
4%	14.400V	94.97kΩ
5%	14.250V	64.87kΩ
6%	14.100V	44.92kΩ
7%	13.950V	30.72kΩ
8%	13.800V	20.10kΩ
9%	13.650V	11.86kΩ
10%	13.500V	5.28kΩ

DHWXXS24-50		
Trim	V _{out,up}	R _{up}
2%	24.480V	247.2kΩ
4%	24.960V	109.255kΩ
6%	25.440V	63.38kΩ
8%	25.920V	39.025kΩ
10%	26.400V	27.52kΩ
12%	26.880V	18.39kΩ
14%	27.360V	11.77kΩ
16%	27.840V	7.29kΩ
18%	28.320V	3.308kΩ
20%	28.800V	0.3658kΩ

DHWXXS24-50		
Trim	V _{out,down}	R _{down}
1%	23.760V	318.05kΩ
2%	23.520V	146.05kΩ
3%	23.280V	85.8kΩ
4%	23.040V	55.51kΩ
5%	22.800V	37.415kΩ
6%	22.560V	25.625kΩ
7%	22.320V	16.515kΩ
8%	22.080V	9.81kΩ
9%	21.840V	4.9785kΩ
10%	21.600V	0.9185kΩ

DERATING CURVES

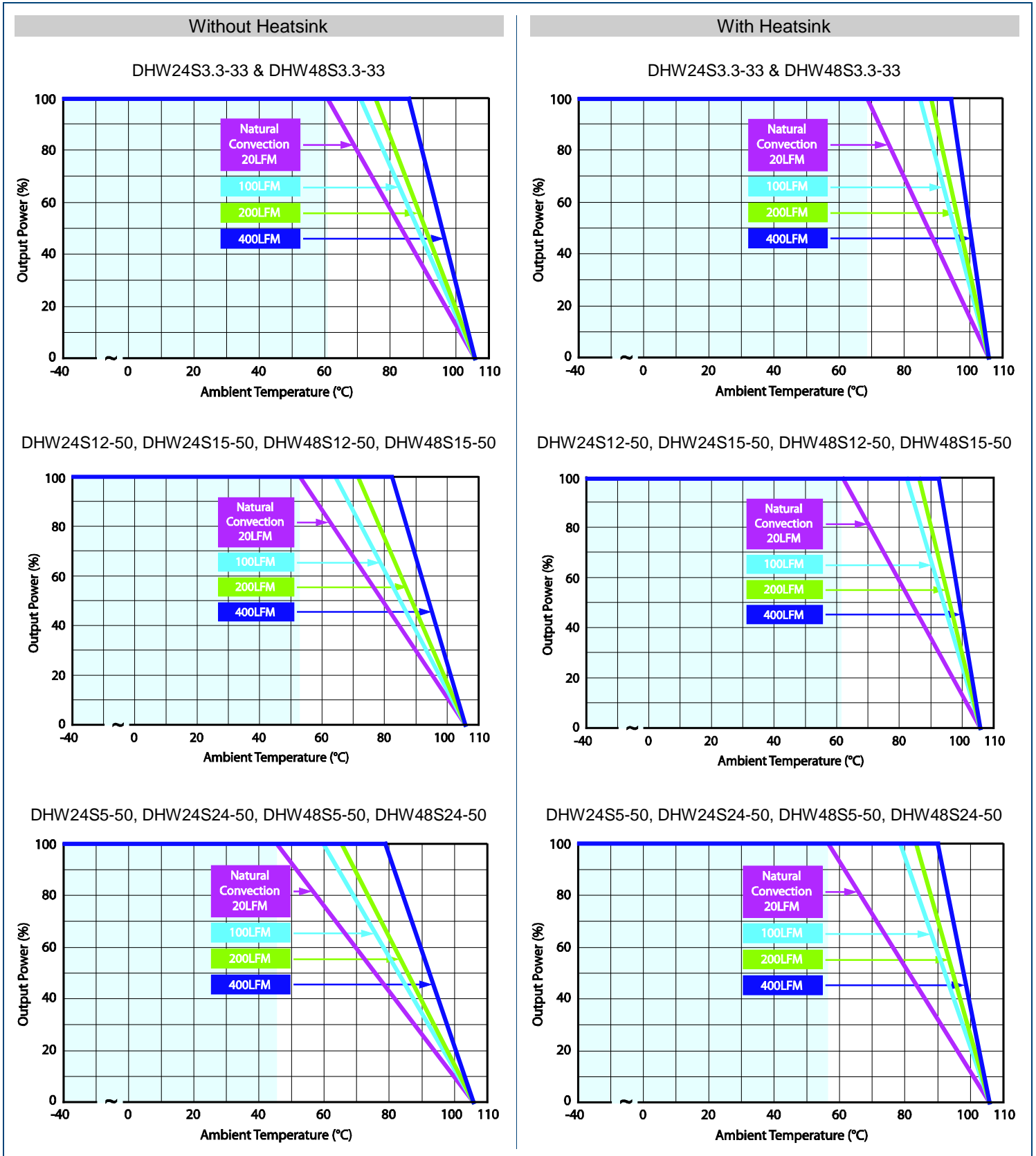

EFFICIENCY CURVES

24VDC NOMINAL INPUT MODELS

DHW24S3.3-33 Efficiency vs Load Current

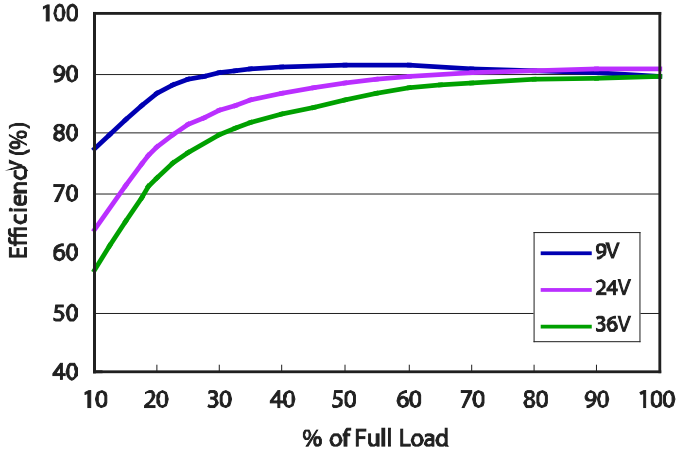

DHW24S5-50 Efficiency vs Load Current

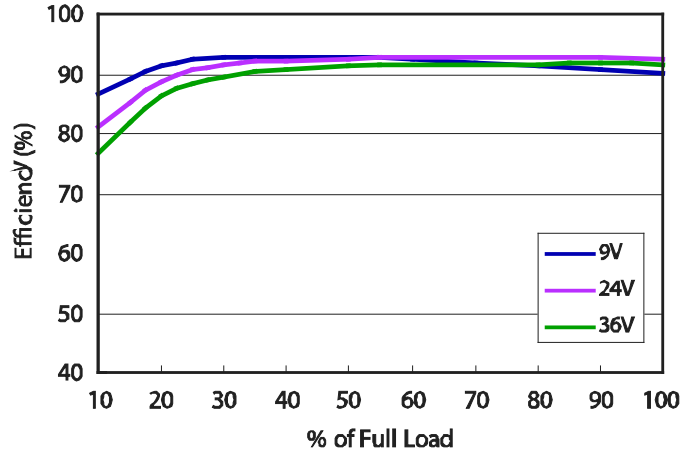

DHW24S12-50 Efficiency vs Load Current

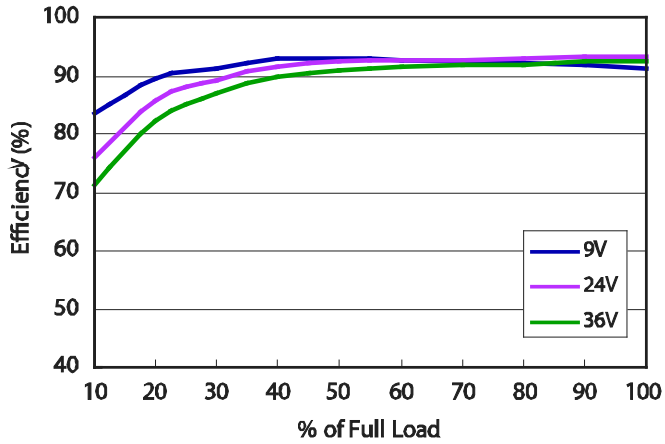

DHW24S15-50 Efficiency vs Load Current

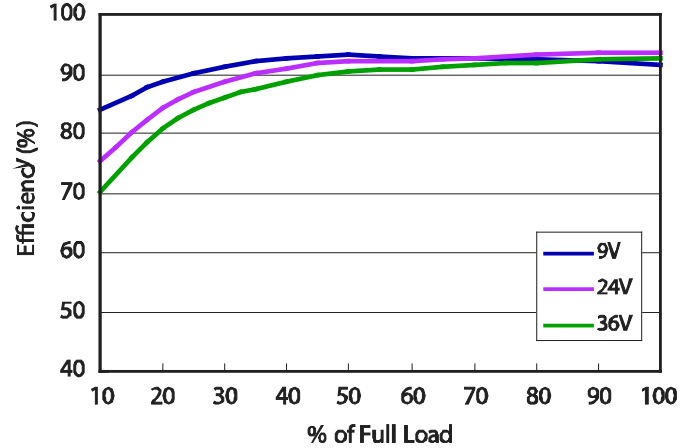

DHW24S24-50 Efficiency vs Load Current

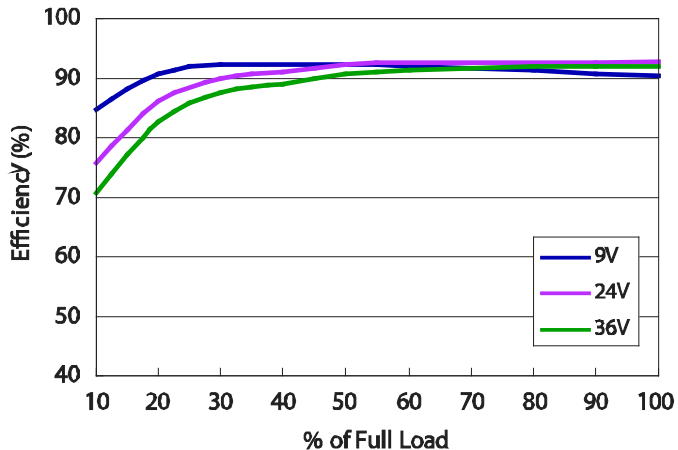

EFFICIENCY CURVES

48VDC NOMINAL INPUT MODELS

DHW48S3.3-33 Efficiency vs Load Current

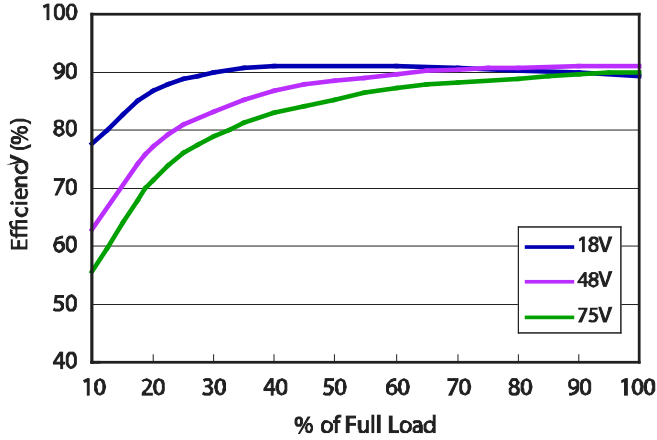

DHW48S5-50 Efficiency vs Load Current

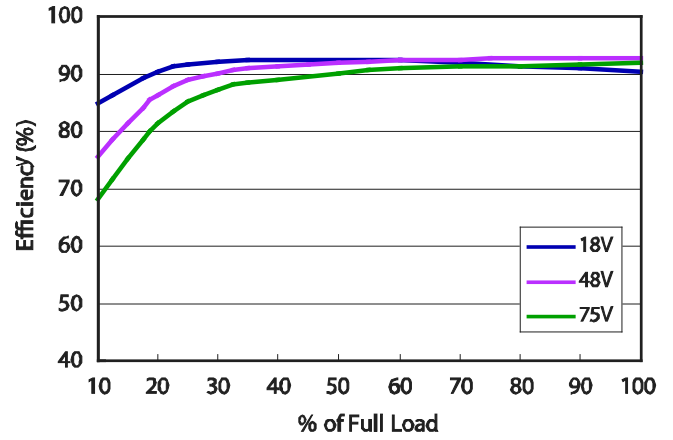

DHW48S12-50 Efficiency vs Load Current

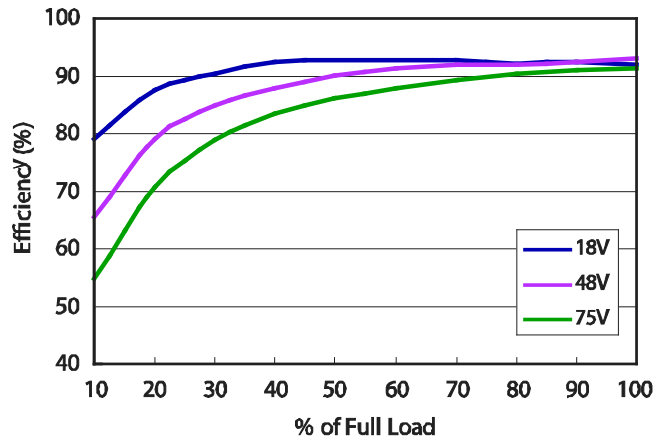

DHW48S15-50 Efficiency vs Load Current

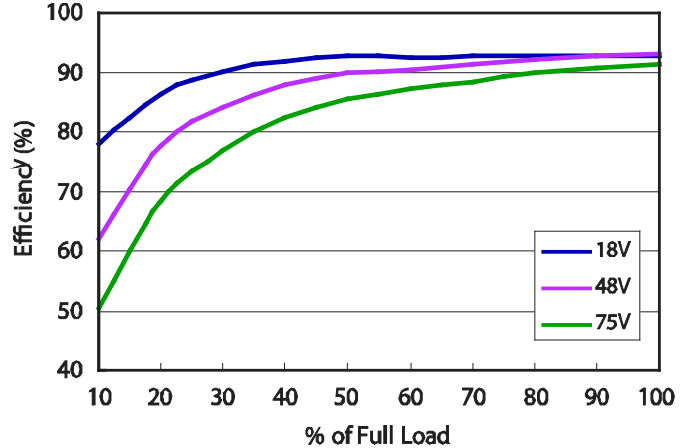

DHW48S24-50 Efficiency vs Load Current

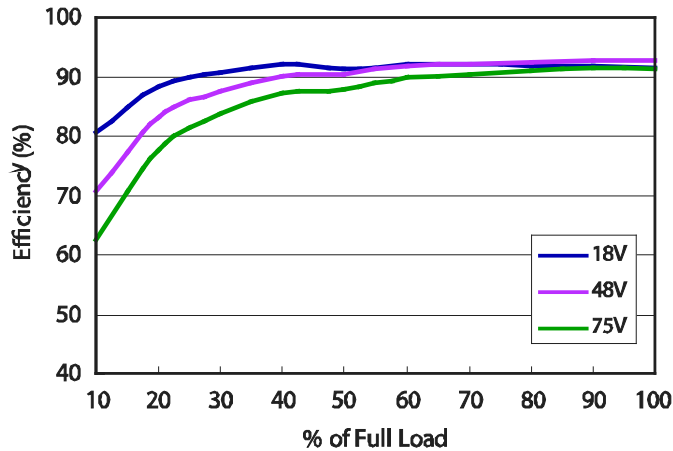

EUT

Operating Modes of EUT and Determination of Worst Case Operating Mode

Test modes presented in report below.

Conducted & Radiated Emission Test			
Mode	Model No.	Input	Output
1	DHW12S3.3-33	12VDC	3.3VDC
2	DHW24S24-50	24VDC	24VDC
3	DHW48S24-50	48VDC	24VDC
4	DHW48S3.3-33	48VDC	3.3VDC
Immunity Tests			
Mode	Model No.	Input	Output
3	DHW48S24-50	48VDC	24VDC

Test Program Used and Operation Description

Emission Test: Set the EUT under full resistor load.

Immunity Tests: Connected a resistor load to DC output port of EUT to make EUT have maximum power consumption and a multimeter was used to monitor voltage of output.

Primary Clock Frequencies of Internal Source

The highest frequency generated or used within the EUT or on which the EUT operates or tunes is below 108MHz, provided by factory, for detailed internal source, please refer to manufacturers specifications.

EMI FILTER

Conduction & Radiation Solution

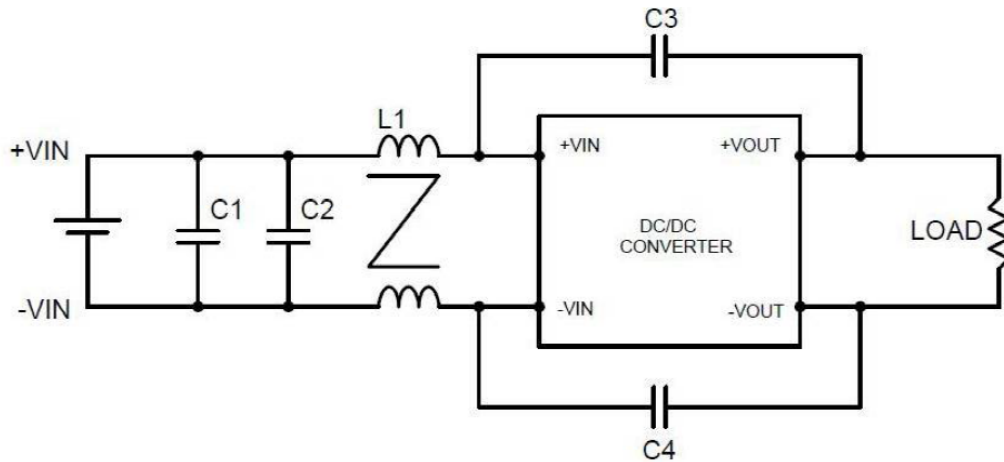

Class	Model	L1	C1	C2	C3, C4
Class A	DHW50 Series	1mH//1mH 7448031501	3.3µF/100V 1210 X7S MLCC	4.7µF/100V 1210 X7S MLCC	1000pF/2kV 1206 X7R MLCC

EFT & Surge Solution:

To meet EN61000-4-4 & EN61000-4-5, an external capacitor across the input pins is required. Suggested capacitor: 330uF/100V.

RADIATION REPORT

Radiation Class A Report

Limit Line: EN55032 Class A
Polarity: Horizontal

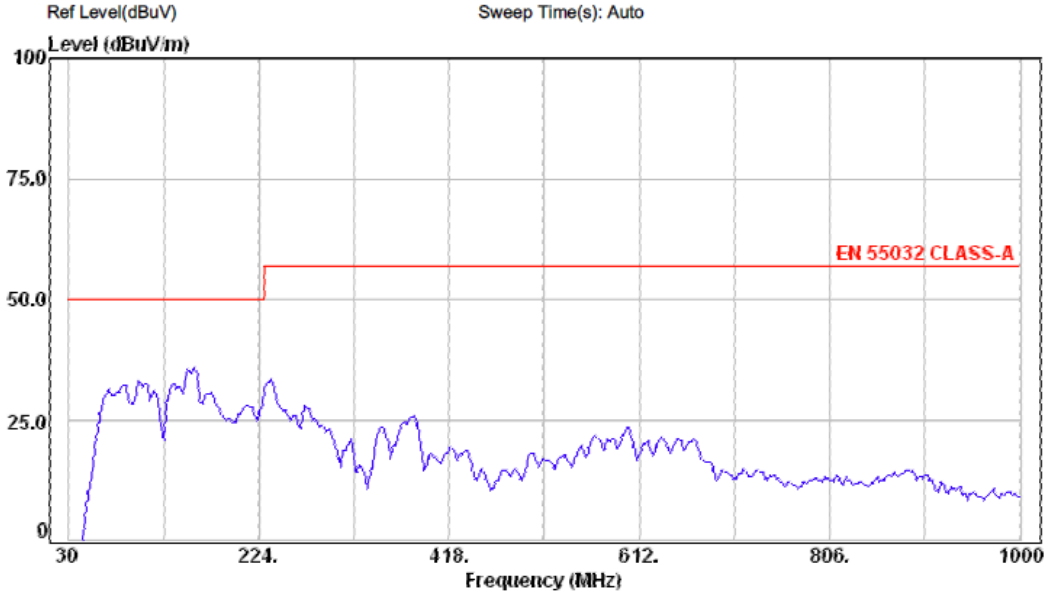

Start Freq: 30MHz Stop Freq: 1000MHz RBW: 120kHz

No.	Freq.(Hz)	Measured level(dB)	Factor (dB)	Reading level (dBuV)	Limit Line (dBuV/m)	Over limit (dBuV)	APos	Tpos
(~dform01)								

Limit Line: EN55032 Class A
Polarity: Vertical

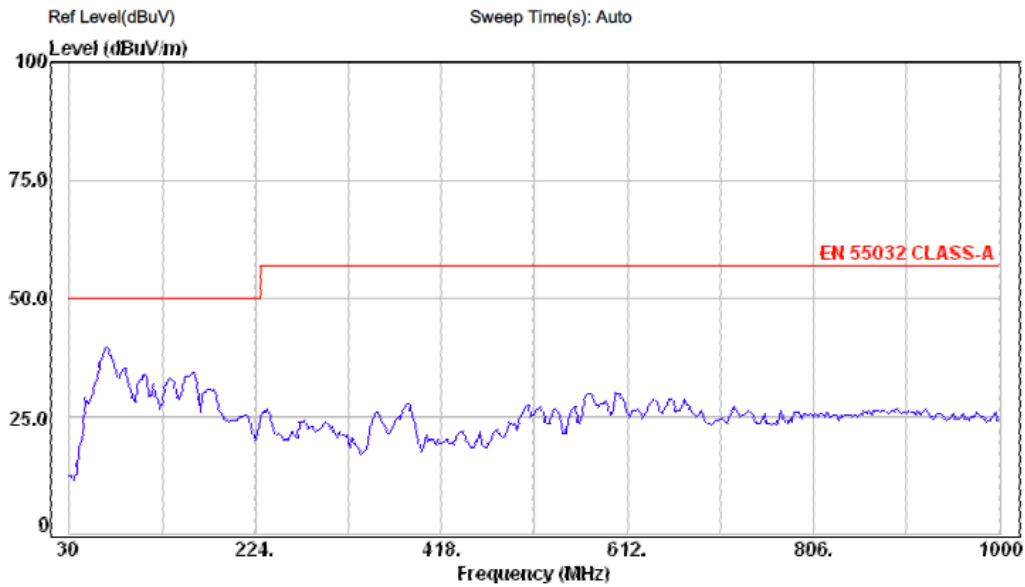

Start Freq: 30MHz Stop Freq: 1000MHz RBW: 120kHz

No.	Freq.(Hz)	Measured level(dB)	Factor (dB)	Reading level (dBuV)	Limit Line (dBuV/m)	Over limit (dBuV)	APos	Tpos
(~dform01)								

TEST SETUP

Input Reflected-Ripple Current Test Setup

Input reflected-ripple current is measured with an inductor L_{in} ($4.7\mu H$) and C_{in} ($220\mu F$, $ESR < 1.0\Omega$ at 100 KHz) to simulate source impedance. Capacitor C_{in} offsets possible battery impedance. Current ripple is measured at the input terminals of the module. Measurement bandwidth is 0-500 KHz.

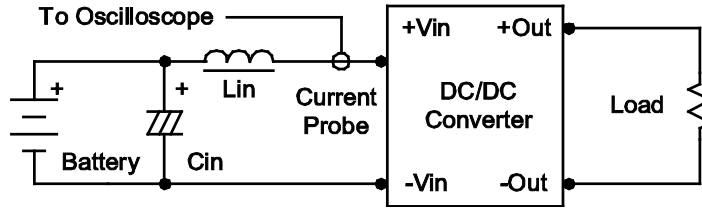

Peak-to-Peak Output Noise Measurement Test

Use a $1\mu F$ ceramic capacitor and a $10\mu F$ tantalum capacitor. Scope measurement should be made by using a BNC socket, measurement bandwidth is 0-20MHz. Position the load between 50mm and 75mm from the DC/DC converter.

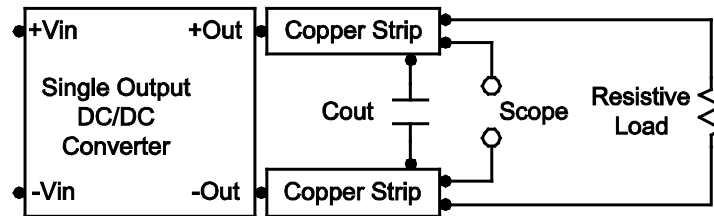

DESIGN & FEATURE CONSIDERATIONS

Remote On/Off

Positive logic remote on/off turns the module on during a logic high voltage on the remote on/off pin and off during a logic low. To turn the module on and off, the user must supply a switch to control the voltage between the on/off terminal and the $-Vin$ terminal. The switch can be an open collector or equivalent. A logic low is 0V to 1.2V. A logic high is 3.5V to 12V. The maximum sink current at on/off terminal (Pin 3) during a logic low is $-100\mu A$.

Over Current Protection

To provide protection in a fault (output overload) condition, the unit is equipped with internal current limiting circuitry and can endure overload for an unlimited duration.

Over Voltage Protection

The output over voltage clamp consists of control circuitry which is independent of the primary regulation loop that monitors the voltage on the output terminals. The control loop of the clamp has a higher voltage set point than the primary loop. This provides a redundant voltage control that reduces the risk of output over voltage. The OVP level can be found in the model selection table.

Output Ripple Reduction

A good quality low ESR capacitor placed as close as possible across the load will give the best ripple and noise performance. To reduce output ripple, it is recommended to use $4.7\mu F$ capacitors at the output.

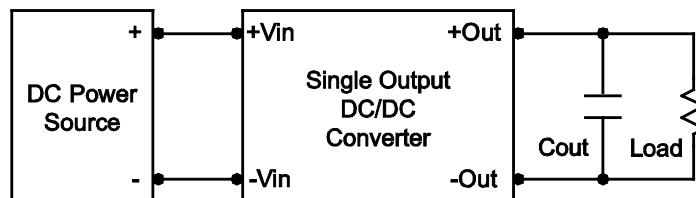

Input Source Impedance

The power module should be connected to a low ac-impedance input source. Highly inductive source impedances can affect the stability of the power module.

In applications where power is supplied over long lines and output loading is high, it may be necessary to use a capacitor at the input to ensure startup.

A Capacitor mounted close to the power module helps ensure stability of the unit, it is recommended to use a good quality low Equivalent Series Resistance (ESR < 1.0Ω at 100KHz) capacitor of a 10μF for the 24V and 48V devices.

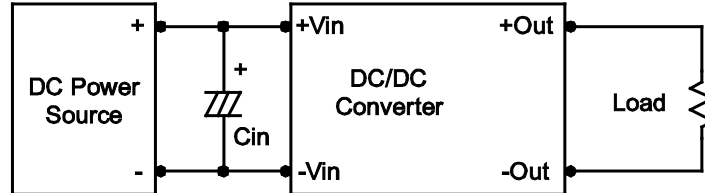

Maximum Capacitive Load

The DHW50 series has a limitation of maximum connected capacitance on the output. The power module may be operated in current limiting mode during start-up, affecting the ramp-up and the start-up time. The maximum capacitance can be found in the model selection table.

Thermal Considerations

Many conditions affect the thermal performance of the power module, such as orientation, airflow over the module, and board spacing. To avoid exceeding the maximum temperature rating of the components inside the power module, the case temperature must be kept below 105°C. The derating curves are determined from measurements obtained in a test setup.

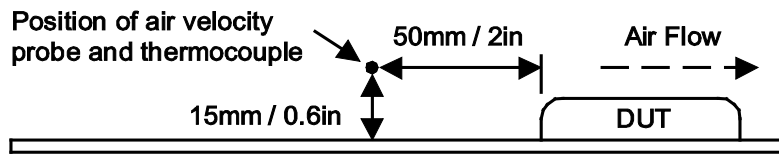

MODEL NUMBER SETUP

DHW	24	S	12	-	50	HS
Series Name	Input Voltage	Output Quantity	Ouput Voltage		Output Power	Heatsink
	24: 9-36 VDC 48: 18-75 VDC	S: Single Output	3.3: 3.3 VDC 5: 5 VDC 12: 12 VDC 15: 15 VDC 24: 24 VDC		33: 33 Watts 50: 50 Watts	None: No Heatsink HS: Heatsink

COMPANY INFORMATION

Wall Industries, Inc. has created custom and modified units for over 50 years. Our in-house research and development engineers will provide a solution that exceeds your performance requirements on-time and on budget. Our ISO9001-2008 certification is just one example of our commitment to producing a high quality, well-documented product for our customers.

Our past projects demonstrate our commitment to you, our customer. Wall Industries, Inc. has a reputation for working closely with its customers to ensure each solution meets or exceeds form, fit and function requirements. We will continue to provide ongoing support for your project above and beyond the design and production phases. Give us a call today to discuss your future projects.

Contact **Wall Industries** for further information:

Phone:	☎ (603)778-2300
Toll Free:	☎ (888)597-9255
Fax:	☎ (603)778-9797
E-mail:	sales@wallindustries.com
Web:	www.wallindustries.com
Address:	37 Industrial Drive Exeter, NH 03833